



C



Low voltage cylindrical fuses

Cylindrical fuse-links **784**

Fuse-switch disconnectors

for cylindrical fuse-links **800**

*DC and PV fuses are in Special Purpose Fuses and Green Protect catalogues

f @ in v
/etigroup

ETI
SWITCH TO
A SAFE FUTURE

C Cylindrical fuse-links

Cylindrical fuse-link CH

Rated current
0,16-125 A

Fusing characteristic
gG, aM

Application: Cylindrical fuse-links are used as the most secure protection of electrical installations, control, and signal circuits against overloads and short circuit currents. Their dimensions comply with IEC 60269-1 and IEC 60269-2. They are used mainly in industrial areas, since their dimensions allow voltages of up to 690 V. The most common sizes are the following four: 8x32, 10x38, 14x51 and 22x58.

Technical data

Rated voltage	400 V AC, 500 V AC, 690 V AC	
Rated current	CH 8	0,5-25 A/400 V
	CH 10	0,16-20 A/500 V(25 A/500 V gG), 25-32 A/400 V
	CH 14	0,25-25 A/690 V, 32-50 A/500 V
	CH 22	1-80 A/690 V, 100-125 A/500 V
Rated frequency	50 Hz	
Rated breaking capacity	CH 8	20 kA
	CH 10	120 kA
	CH 14	120 kA
	CH 22	120 kA
Characteristics	gG, aM	
Body material	ceramic	
Material of contact parts	Cu, gal.Ag	



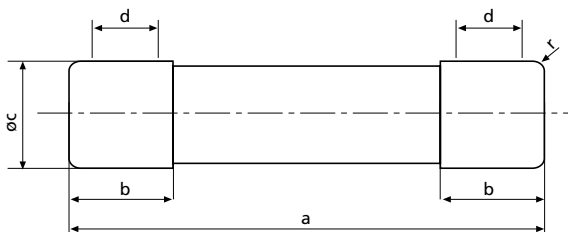

The consequence of using low-quality CH fuse links





size	a	b _{max.}	c	d _{min.*}	r
8 x 32	31,5±0,5	6,7	8,5±0,1	4	1±0,5
10 x 38	38,0±0,6	10,5	10,3±0,1	6	1,5±0,5
14 x 51	51,0+0,6/-1	13,8	14,3±0,1	7,5	±1
22 x 58	58,0+0,1/-2	16,2	22,2±0,1	11	±1

CH 8x32 / 20kA

Rated voltage / Rated current	Code No. gG	Power dissipation (In) Pd [W]	Code No. aM	Power dissipation (In) Pd [W]		
400V	0,5A	0,55			4,4	10/2500
	1A	0,35	002652000	0,09		
	2A	0,45	002652001	0,15		
	4A	0,65	002652002	0,26		
	6A	0,83	002652003	0,35		
	8A	1,0	002652004	0,47		
	10A	1,2	002652005	0,55		
	12A	1,3	002652006	0,7		
	16A	1,7				
	20A	2,0				
	25A	2,4				





CH 10x38 / 120kA

Rated voltage / Rated current	Code No. gG	Power dissipation (In) Pd [W]	Code No. aM	Power dissipation (In) Pd [W]			
500V	0,16A		002652007	0,07	8,3	10/1800	
	0,25A		002652008	0,08			
	0,5A	002651011	0,07	002652009			0,07
	1A	002651012	0,45	002652010			0,1
	2A	002651013	0,5	002652011			0,14
	4A	002651014	0,85	002652012			0,28
	6A	002651015	0,95	002652013			0,38
	8A	002651016	1,15	002652014			0,55
	10A	002651017	1,3	002652015			0,62
	12A	002651018	1,4	002652016			0,82
	16A	002651019	1,9	002652017			0,87
	20A	002651020	2,4	002652018			1,05
	400V	25A	002651021*	002652019			1,2
		32A	002651022	002652020			1,8

* 500V





CH 14x51 / 120kA

Rated voltage / Rated current	Code No. gG	Power dissipation (In) Pd [W]	Code No. aM	Power dissipation (In) Pd [W]			
690V	0,25A		002652021	0,1	21	10/700	
	0,5A		002652022	0,9			
	1A	002651023	0,6	002652023			0,13
	2A	002651024	0,75	002652024			0,18
	4A	002651025	1,1	002652025			0,28
	6A	002651026	1,25	002652026			0,42
	8A	002651027	1,45	002652027			0,55
	10A	002651028	1,65	002652028			0,65
	12A	002651029	1,8	002652029			0,75
	16A	002651030	2,35	002652030			1,05
	20A	002651031	2,75	002652031			1,3
	25A	002651032	3,1	002652032			1,55
	500V	32A	002651033	002652033			2,05
		40A	002651034	002652034			2,65
		45A		002652035			2,85
		50A	002651035	002652036			2,95





C / Cylindrical fuse-links

CH 14x51 with striker pin



Rated voltage / Rated current	Code No. gG	Power dissipation (In) Pd [W]	Code No. aM	Power dissipation (In) Pd [W]		
500V	2A	0,9	006711029	0,2	18,6	10/500
	4A	1	006711030	0,5		
	6A	1,2	006711031	0,4		
	8A	1	006711032	0,7		
	10A	1,3	006711033	0,7		
	12A	1,7	006711034	0,9		
	16A	2	006711035	1,2		
	20A	2,5	006711036	1,2		
	25A	3,3	006711037	1,5		
	32A	2,5	006711038	2		
	40A	4,8	006711039	2,6		
	400V	50A	4,8	006711040		

CH 22x58 / 120kA

Rated voltage / Rated current	Code No. gG	Power dissipation (In) Pd [W]	Code No. aM	Power dissipation (In) Pd [W]					
690V	1A		002652037	0,2	54	10/250			
	2A	002651036	0,9	002652038			0,25		
	4A	002651037	1,25	002652039			0,35		
	6A	002651038	1,4	002652040			0,45		
	8A	002651039	1,6	002652041			0,6		
	10A	002651040	1,9	002652042			0,75		
	12A	002651041	2	002652043			0,85		
	16A	002651042	2,5	002652044			1,15		
	20A	002651043	3,4	002652045			1,35		
	25A	002651044	3,5	002652046			1,7		
	32A	002651045	3,7	002652047			2,2		
	40A	002651046	4,3	002652048			2,7		
	50A	002651047	5,3	002652049			3,6		
	63A	002651048	6,3	002652050			4,8		
	80A	002651049	7,4	002652051			6,2		
	500V	100A	8,3	002652052			6,65		
		125A	11,3	002652053			9,9		



CH 22x58 with striker pin

Rated voltage / Rated current	Code No. gG	Power dissipation (In) Pd [W]	Code No. aM	Power dissipation (In) Pd [W]				
690V	4A	006711008		1,1	51	10/500		
	6A	006711009	006711041	1,3			0,5	
	8A	006711021	006711042	1,1			0,7	
	10A	006711010	006711043	1,5			0,7	
	12A	006711022	006711044	1,8			0,8	
	16A	006711023	006711045	2,1			1,2	
	20A	006711024	006711046	2,7			1,3	
	25A	006711025	006711047	3,3			1,5	
	32A	006711011	006711048	3,5			2,1	
	40A	006711026	006711049	4			3,4	
	50A	006711027	006711050	5,5			3,5	
	63A	006711012	006711051	6,9			4,5	
	500V	80A	006711013	006711052			7,8	5,9
		100A	006711014	006711053			9	6,6

Time current characteristics I/t, CH8 gG

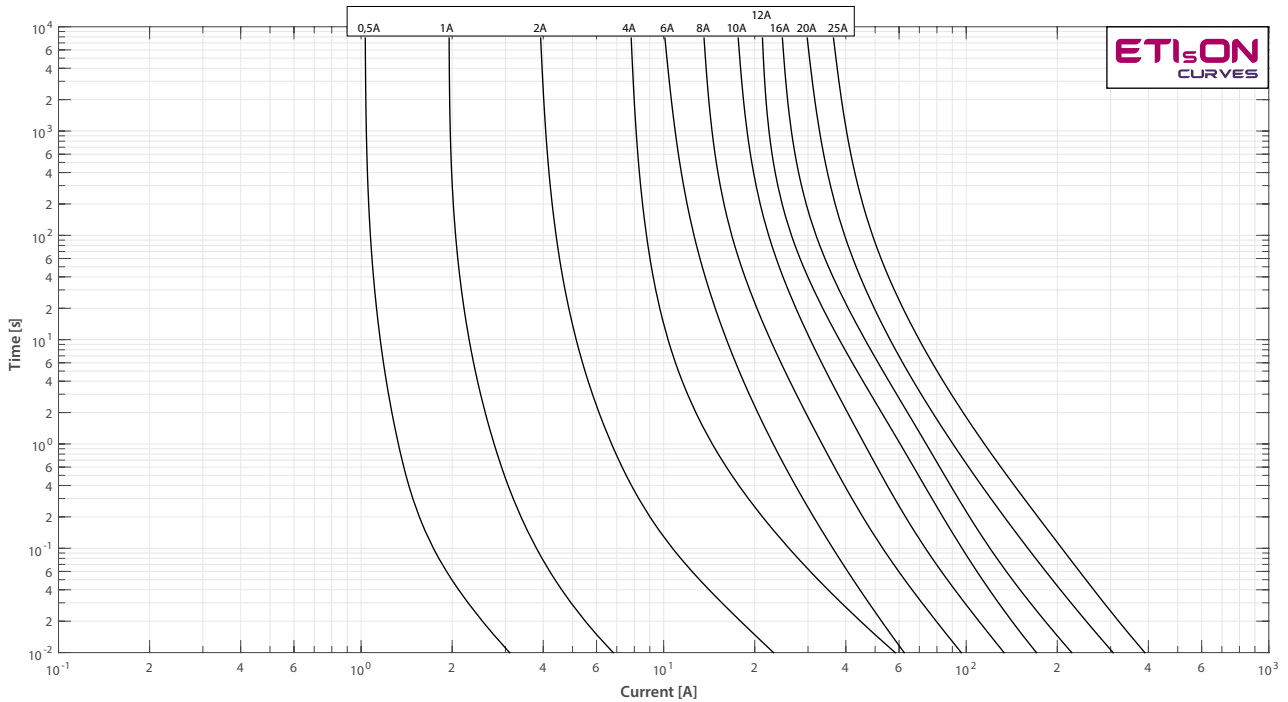

ETIFUSE: Streamline Your Fuse Selection - Interactive Online Tool

C / Cylindrical fuse-links

Cut-off current characteristics, CH8 gG

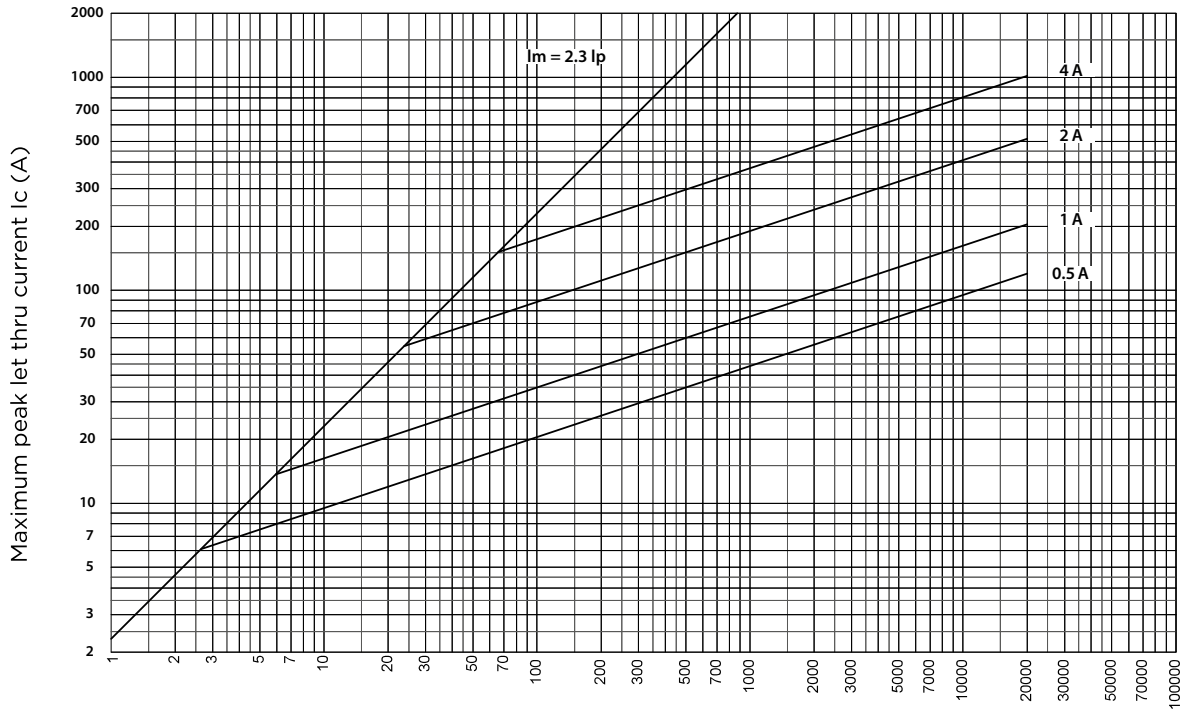

50 Hz RMS symmetrical prospective current I_p (A)

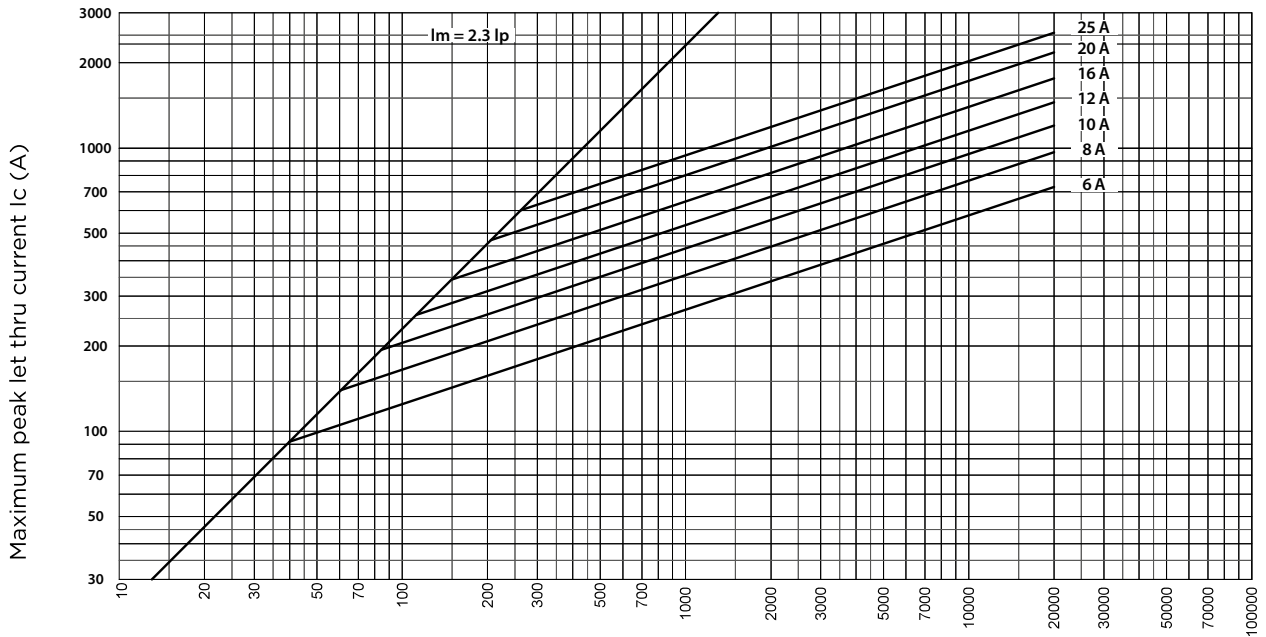

50 Hz RMS symmetrical prospective current I_p (A)

Time current characteristics I/t, CH8 aM

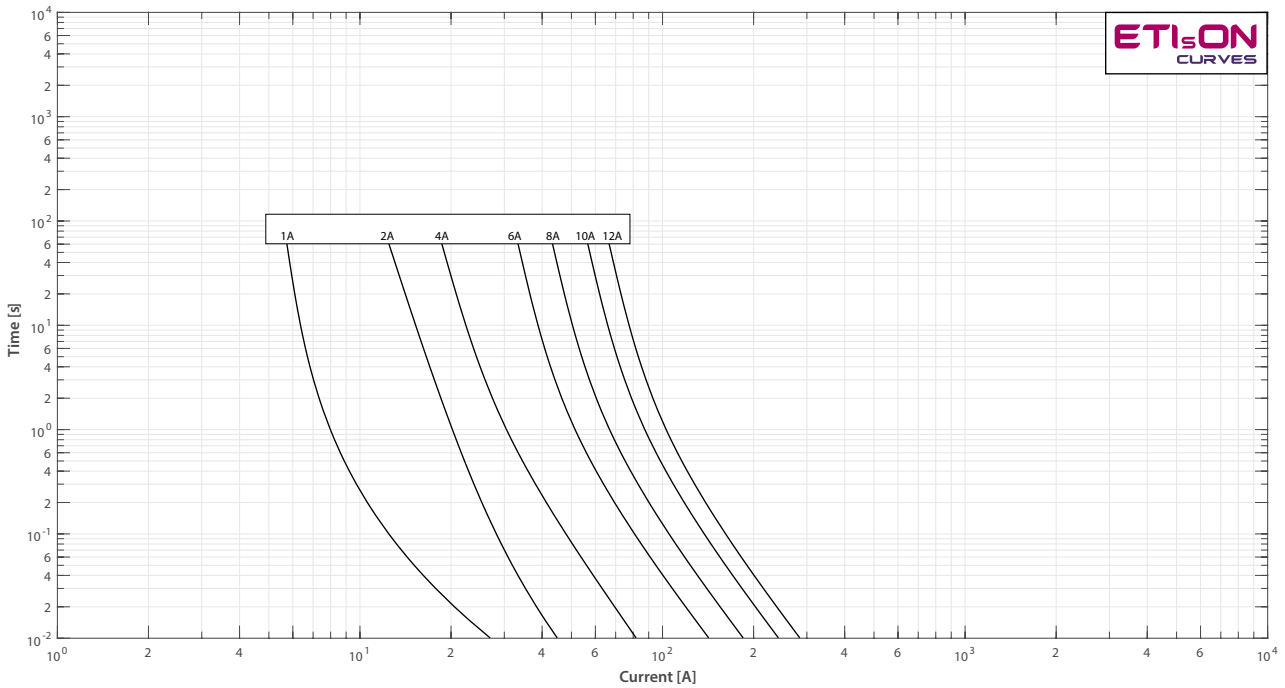

Cut-off current characteristics, CH8 aM

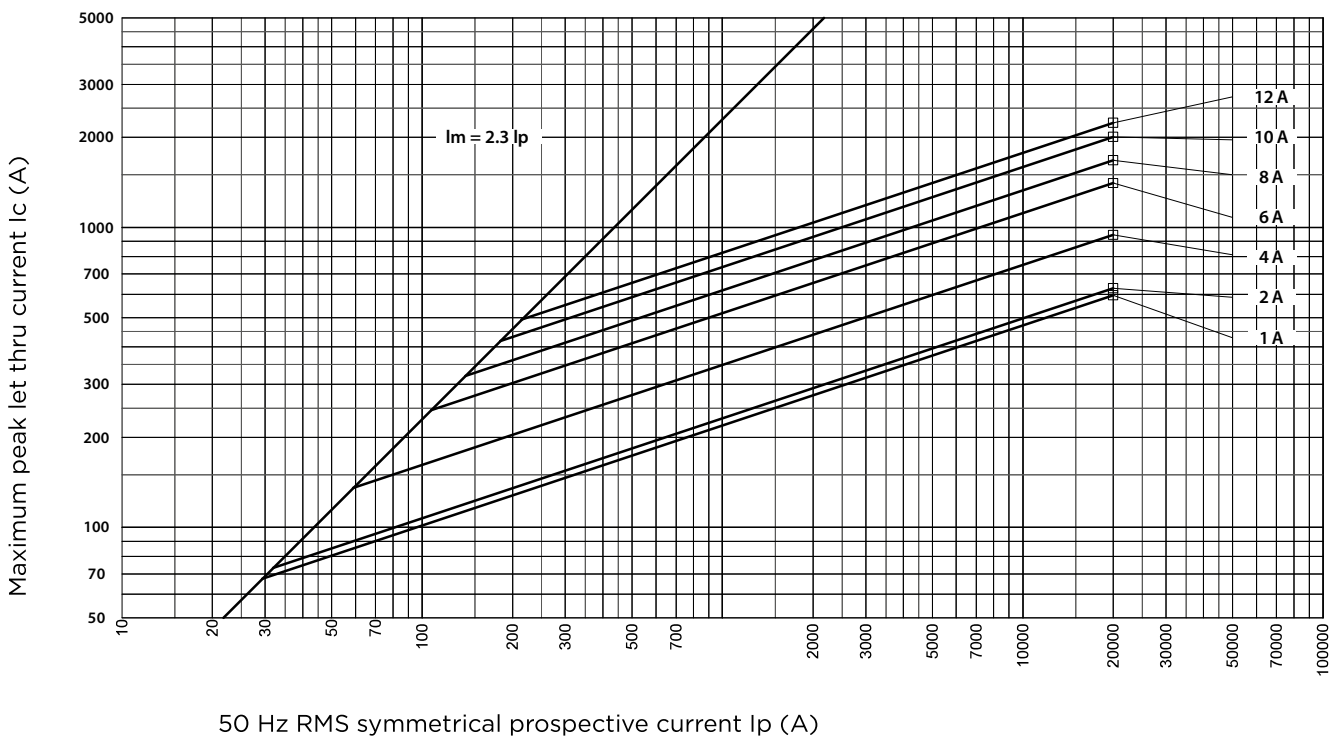

C / Fuse-switch disconnectors for cylindrical fuse-links

Time current characteristics I/t, CH10 gG

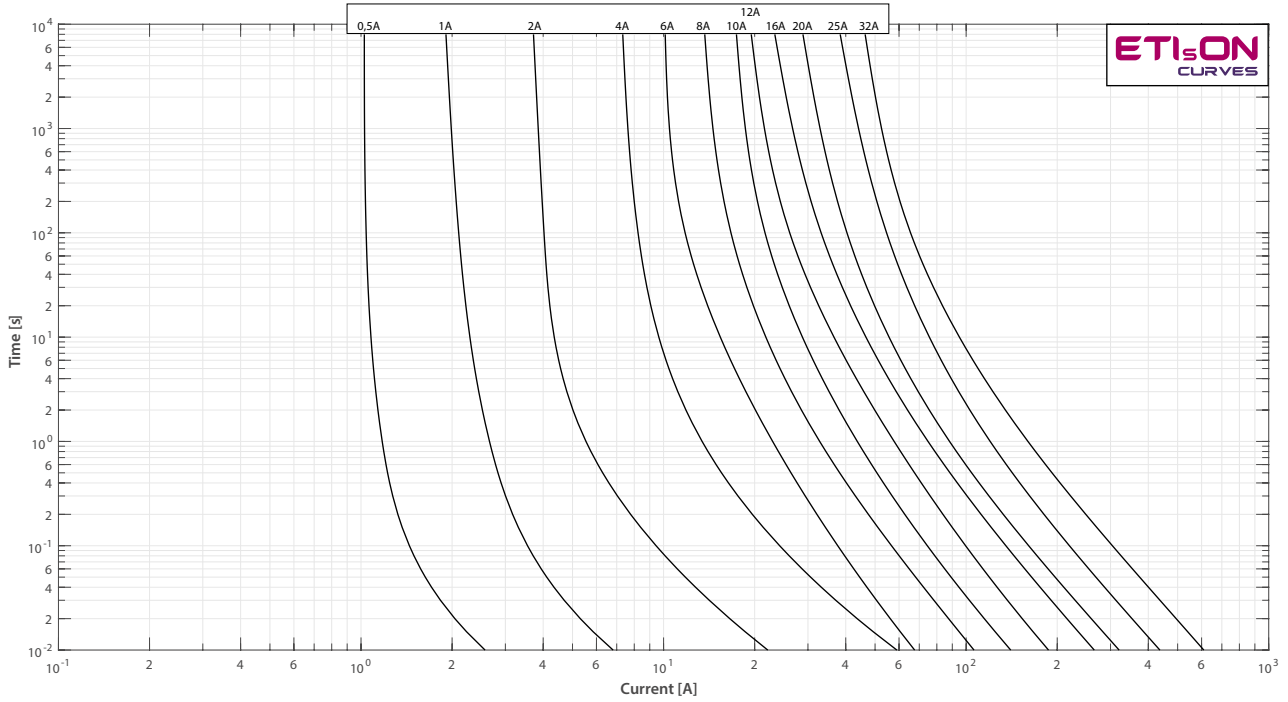

Cut-off current characteristics, CH10 gG

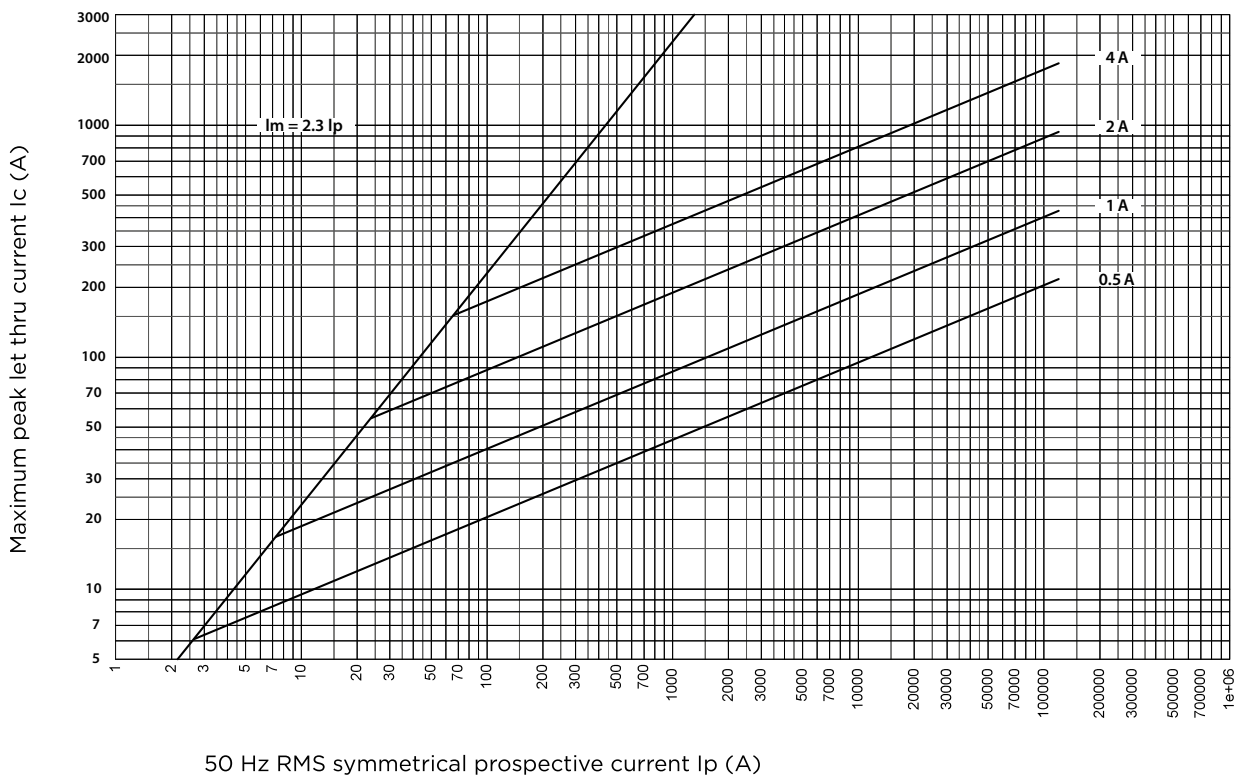

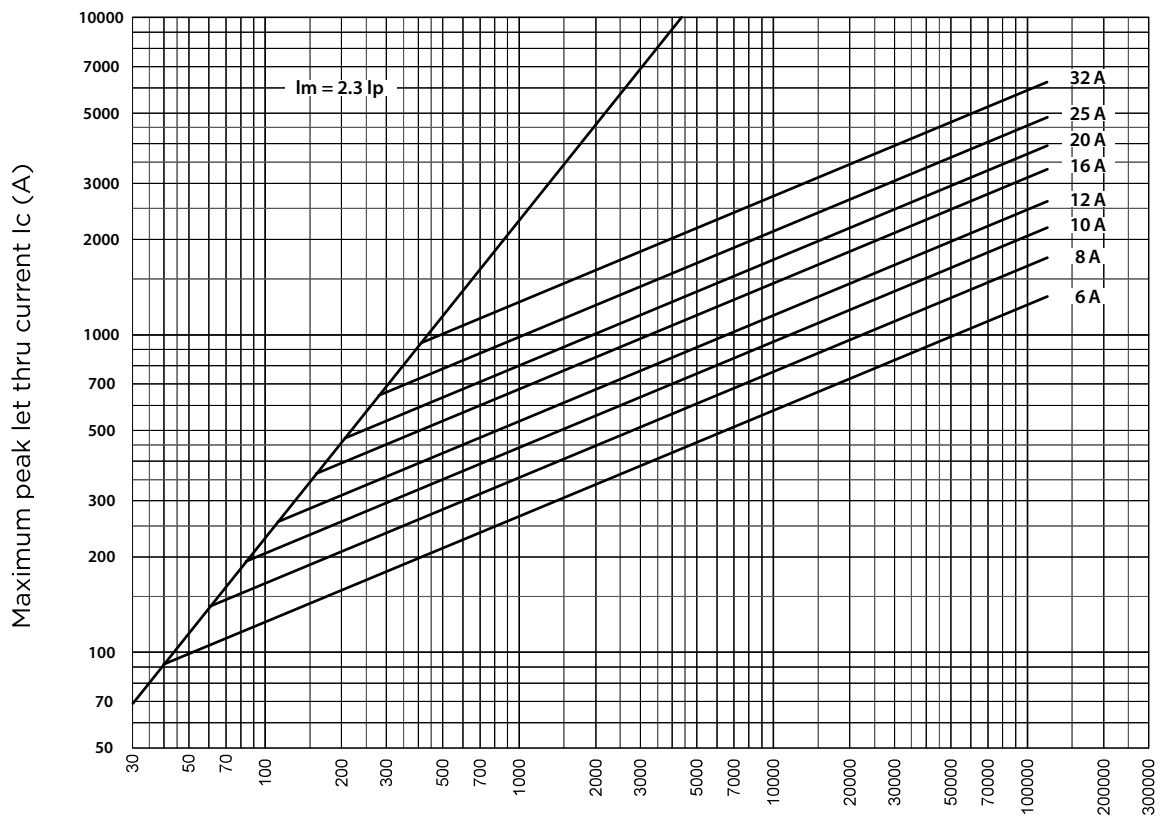

Time current characteristics I/t , CH10 aM

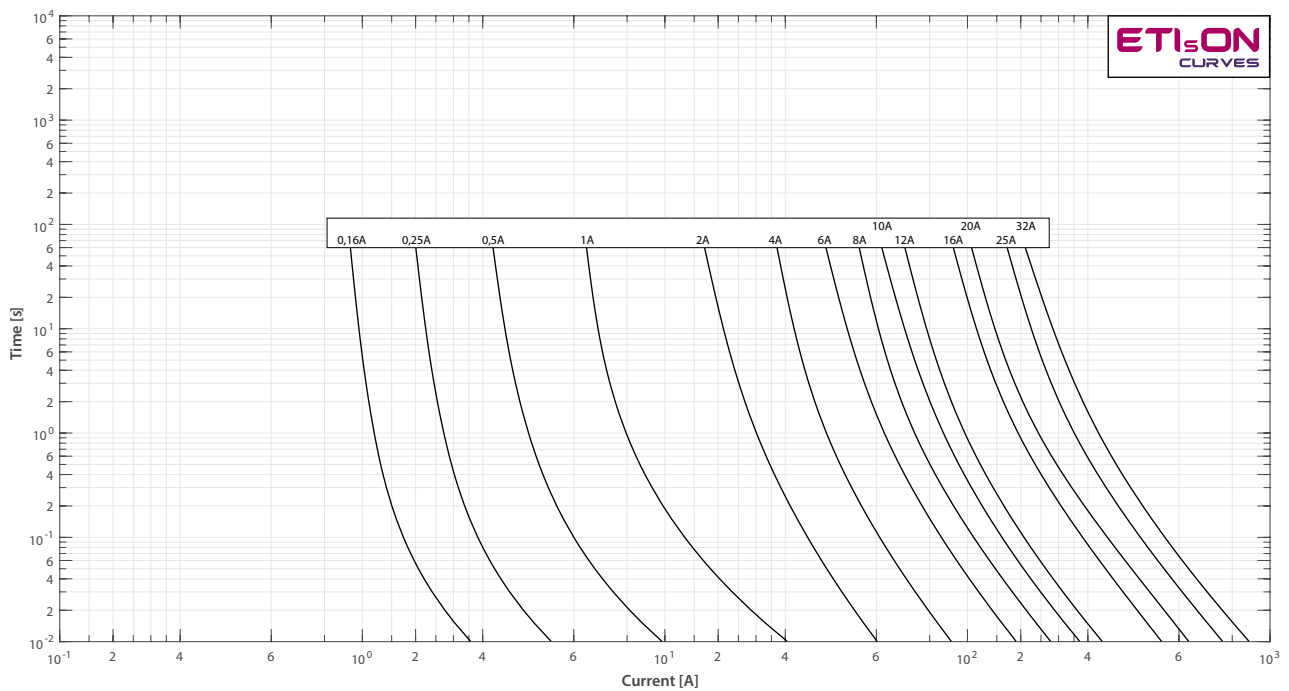

C / Fuse-switch disconnectors for cylindrical fuse-links

Cut-off current characteristics, CH10 aM

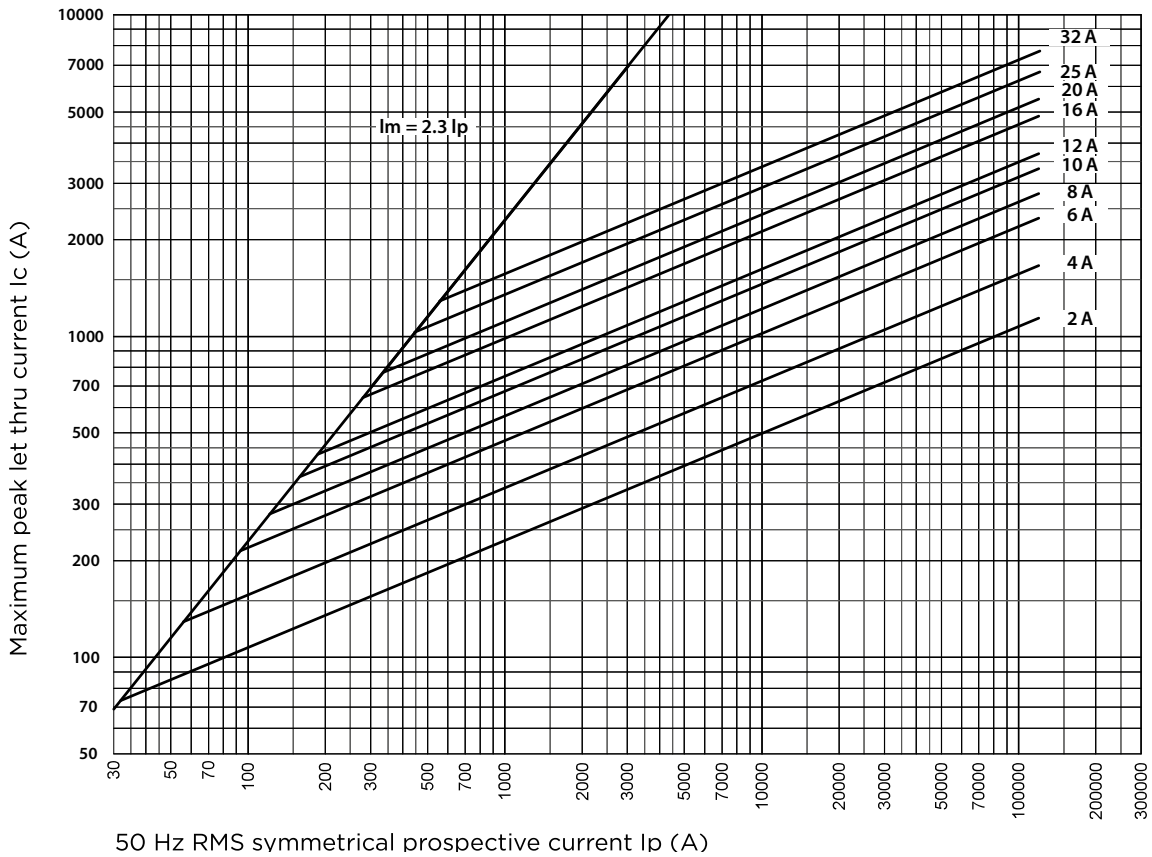
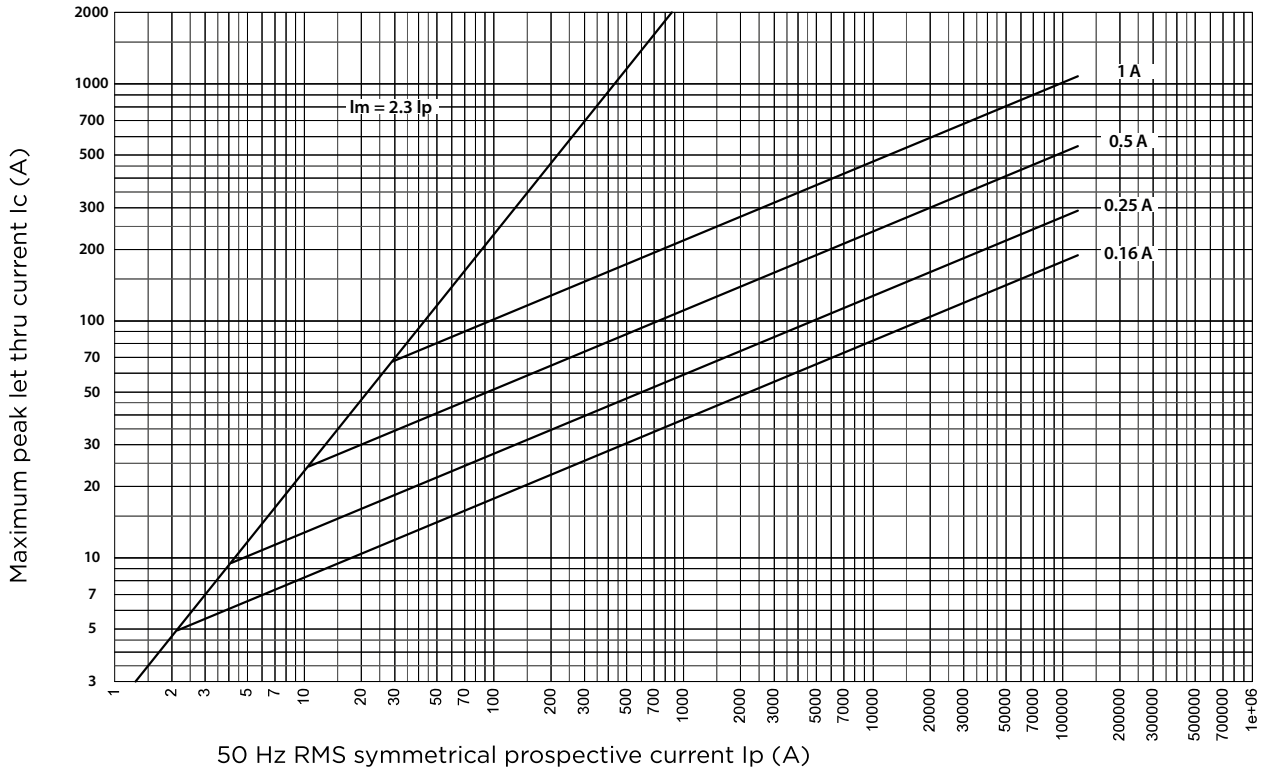

Time current characteristics I/t, CH14 gG

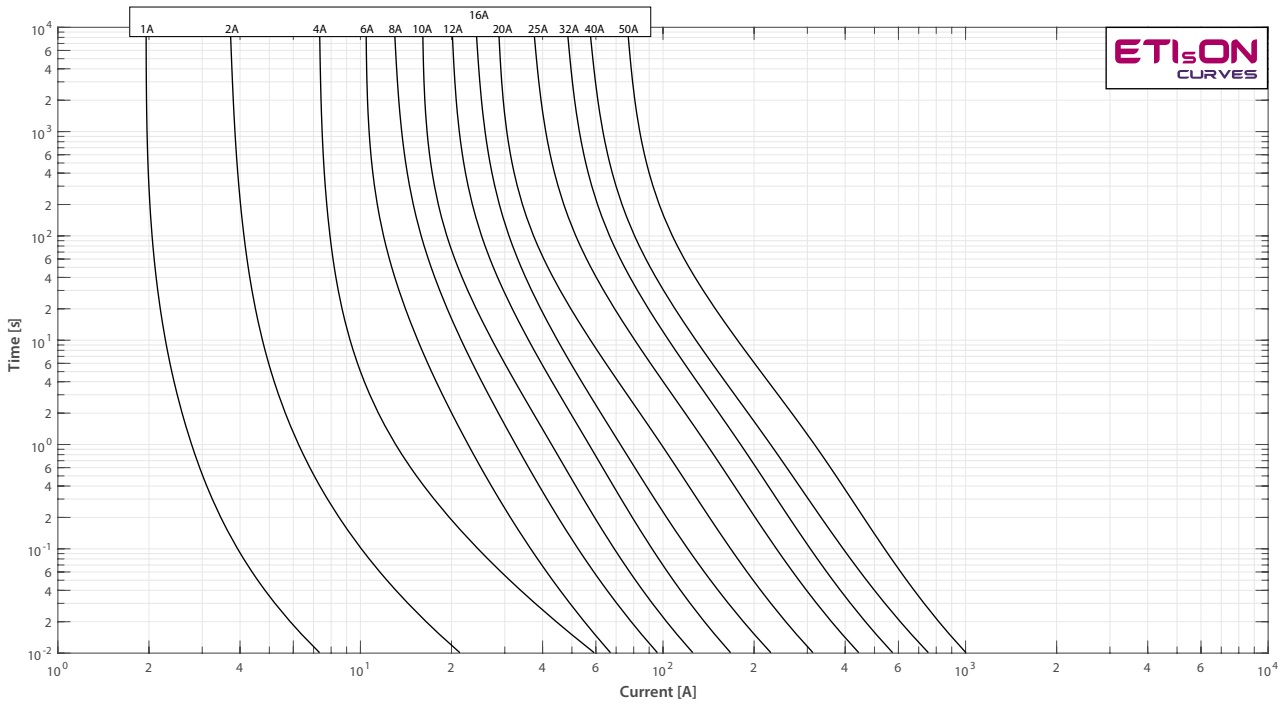

Cut-off current characteristics, CH14 gG

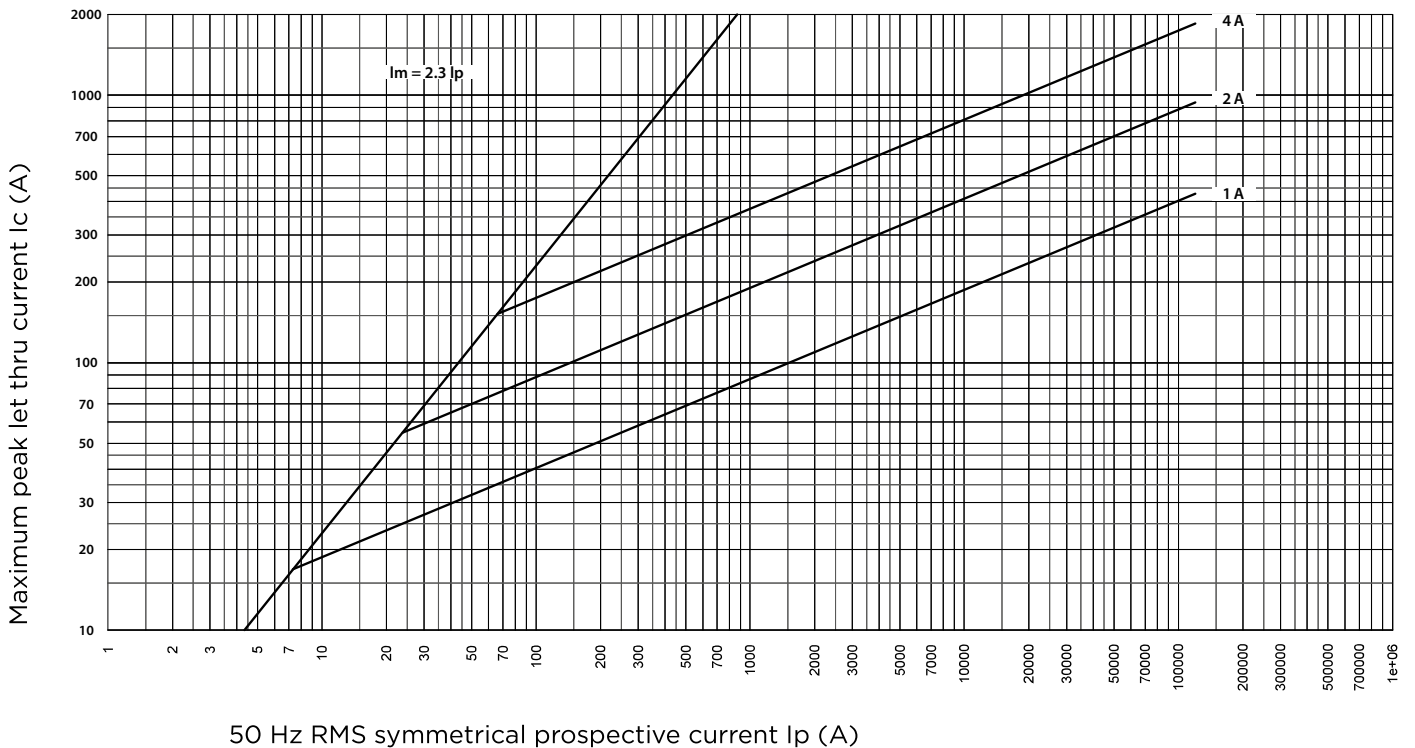

C / Fuse-switch disconnectors for cylindrical fuse-links

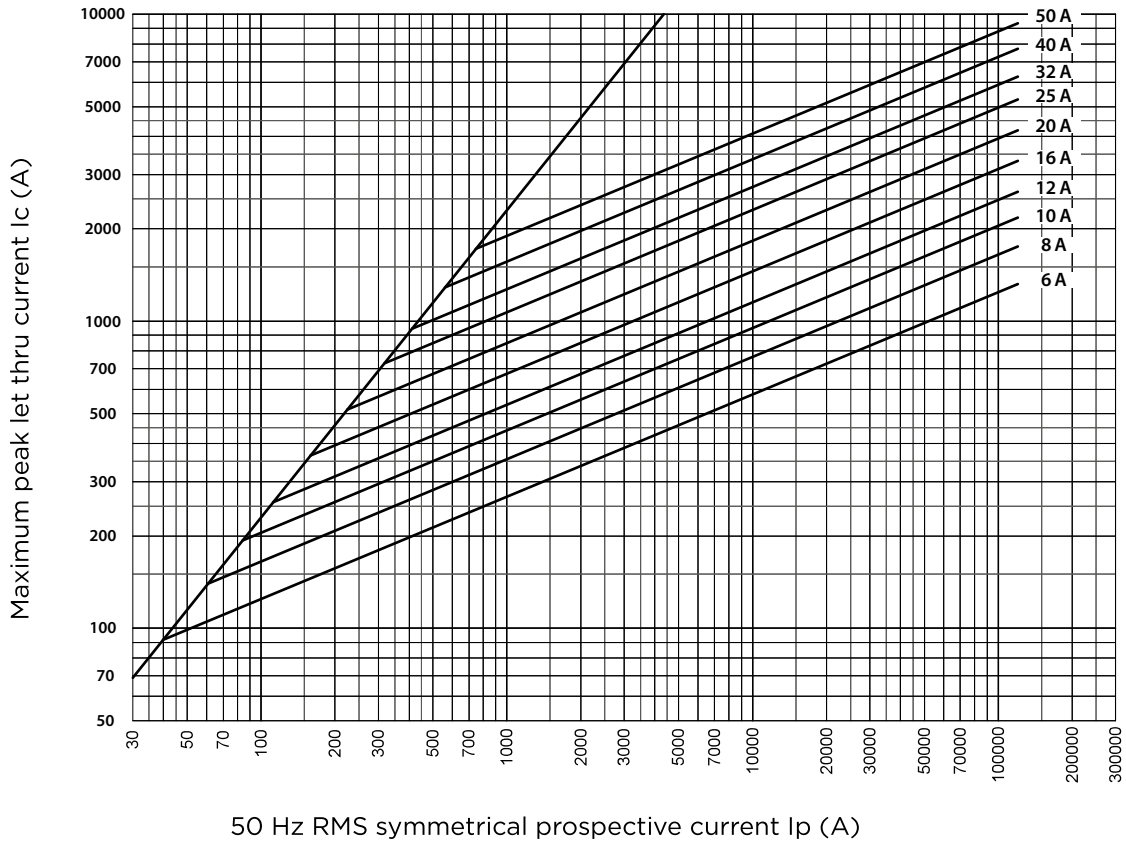

Time current characteristics I/t, CH14 aM

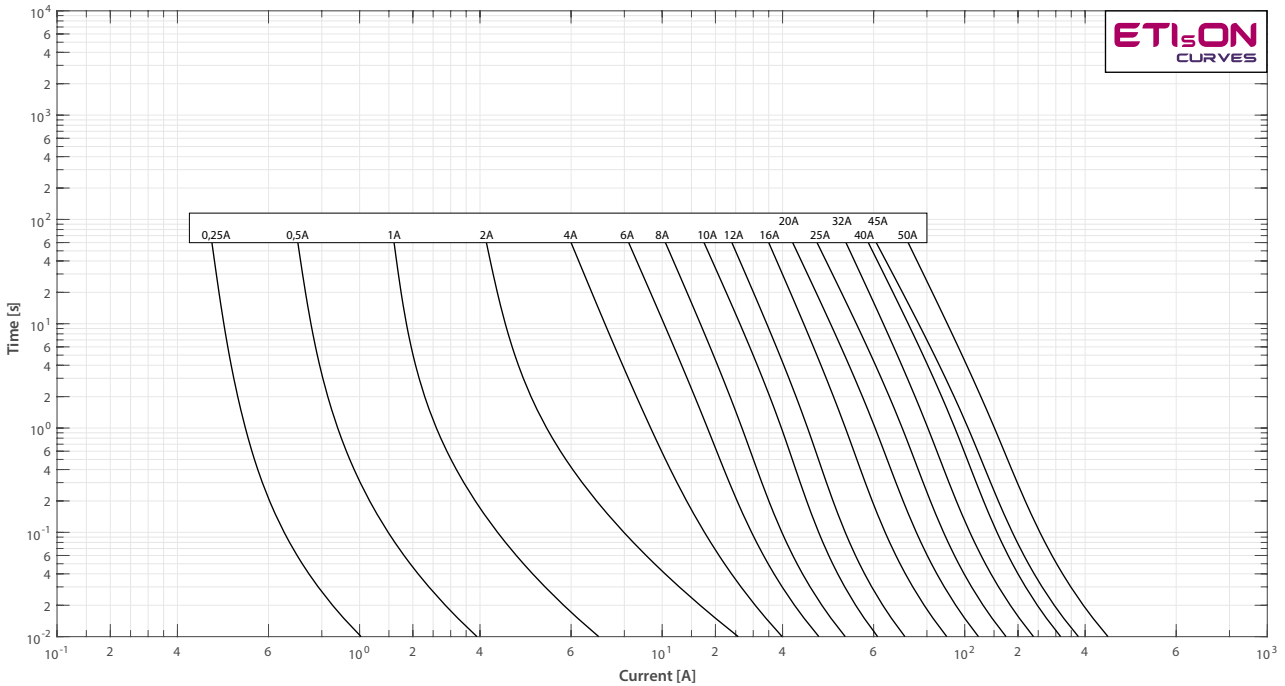

Cut-off current characteristics, CH14 aM

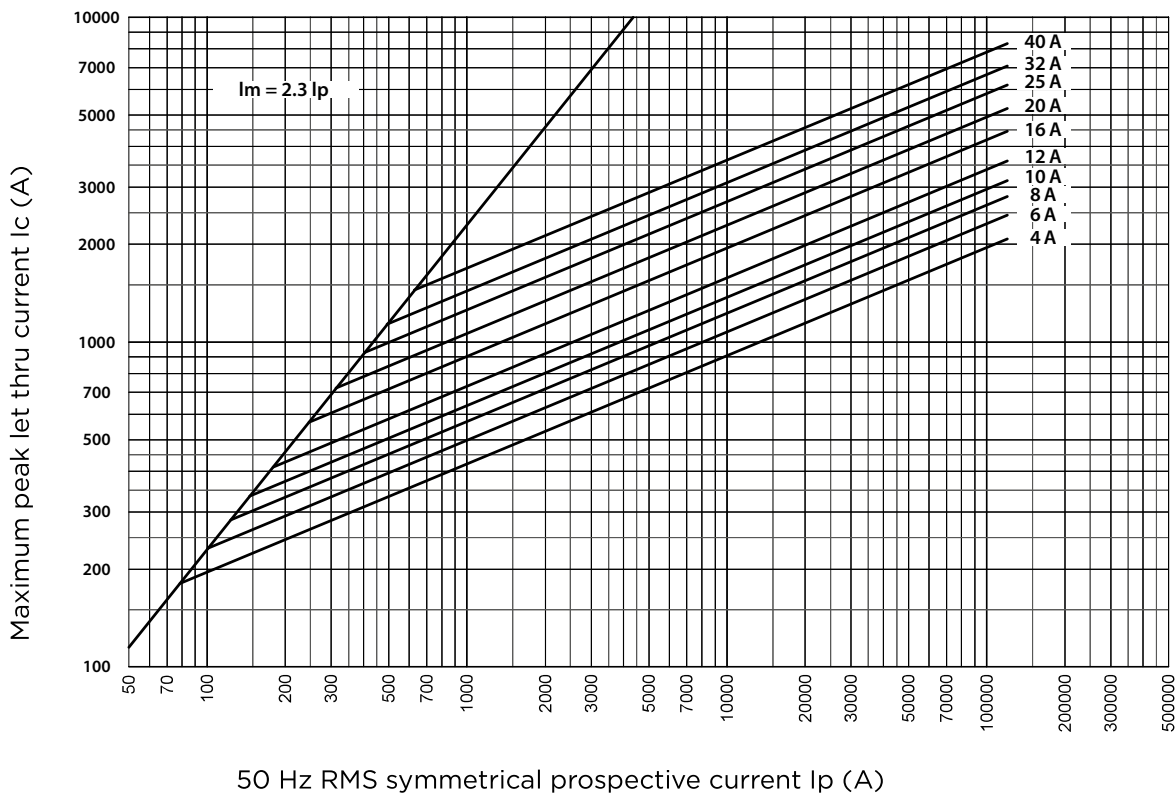
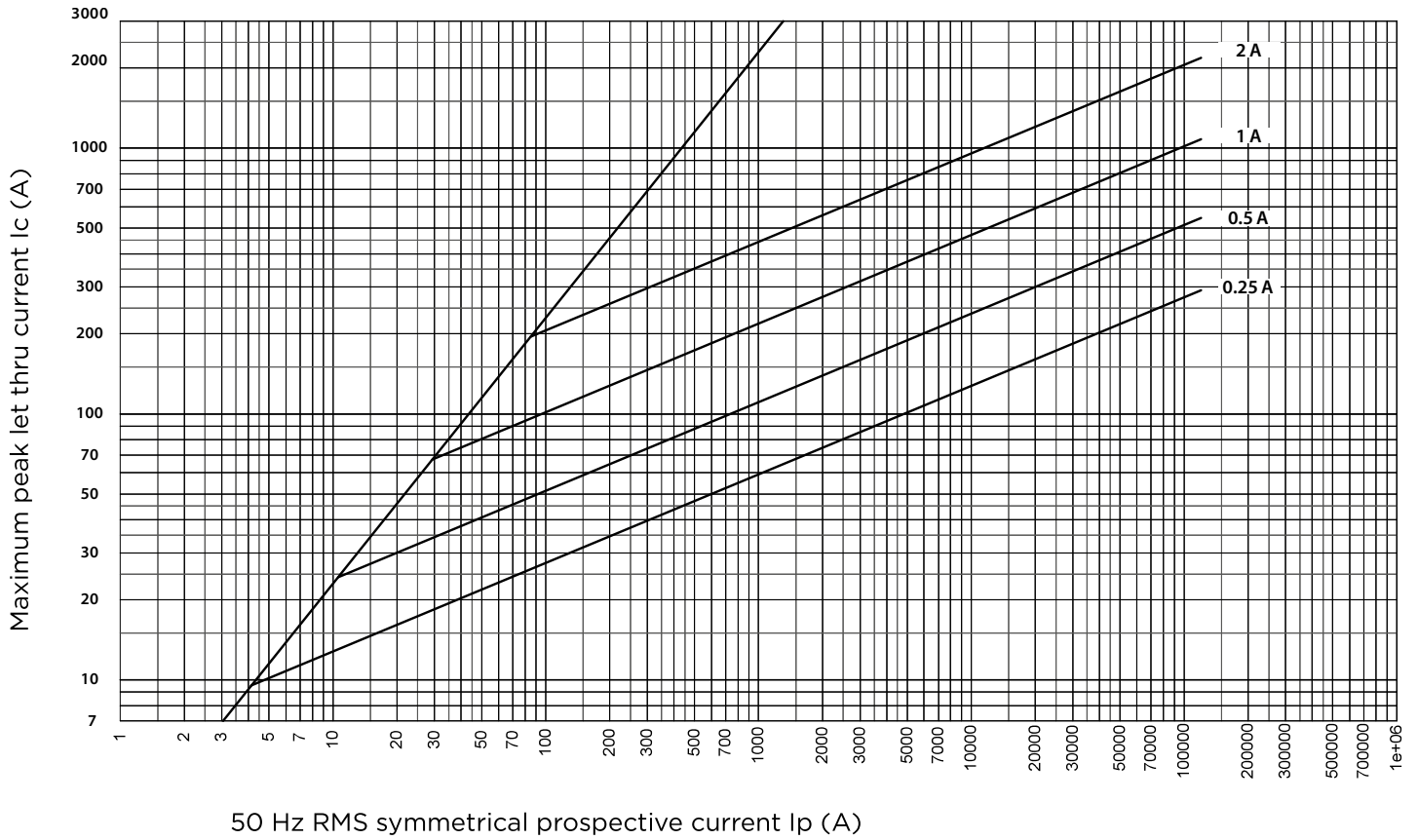

C / Fuse-switch disconnectors for cylindrical fuse-links

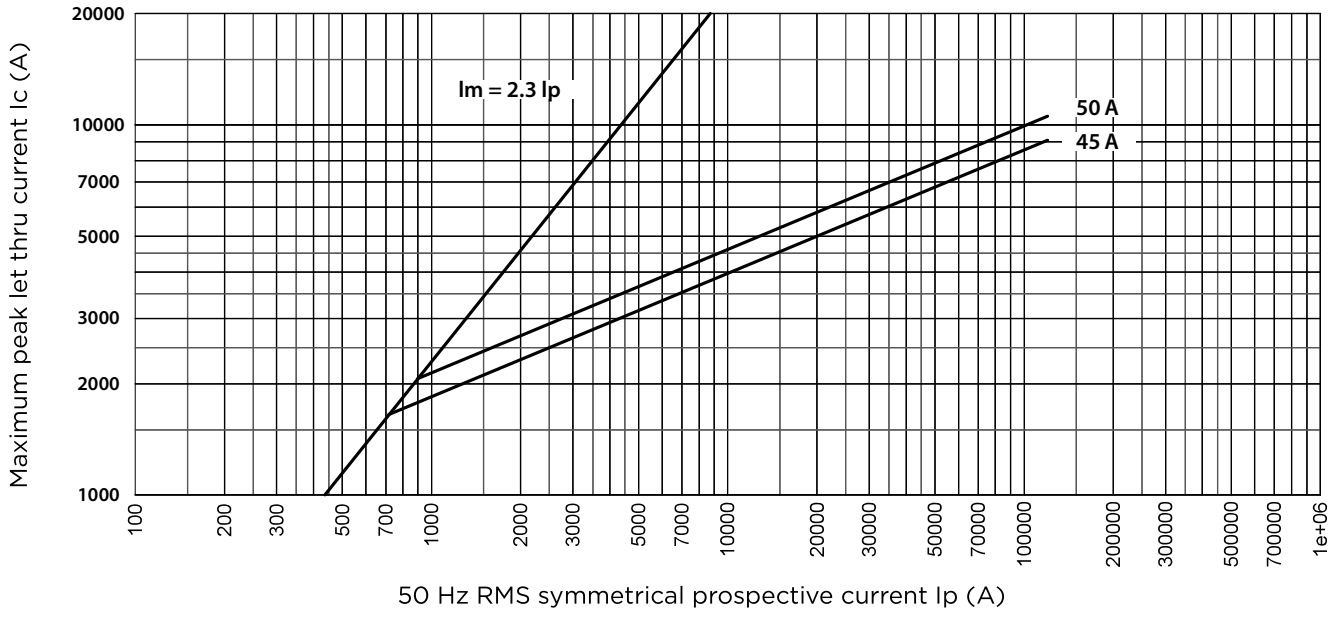

Time current characteristics I/t, CH22 gG

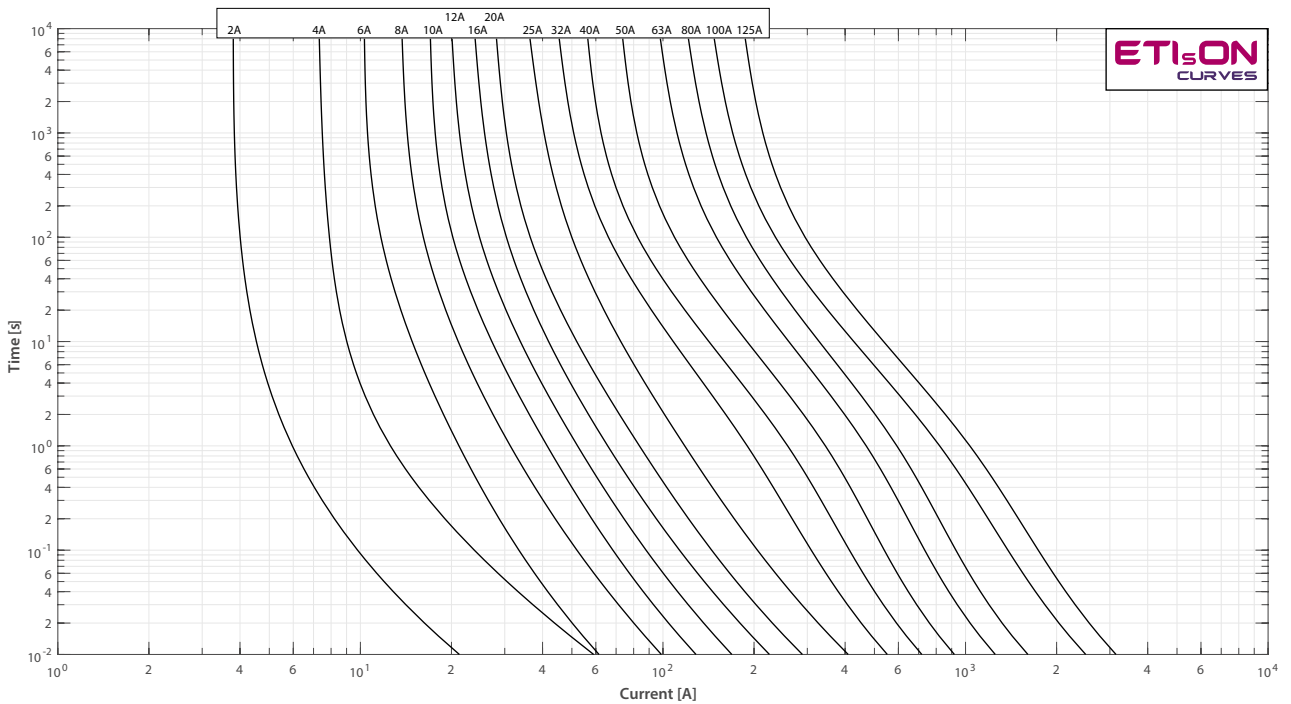

Cut-off current characteristics, CH22 gG

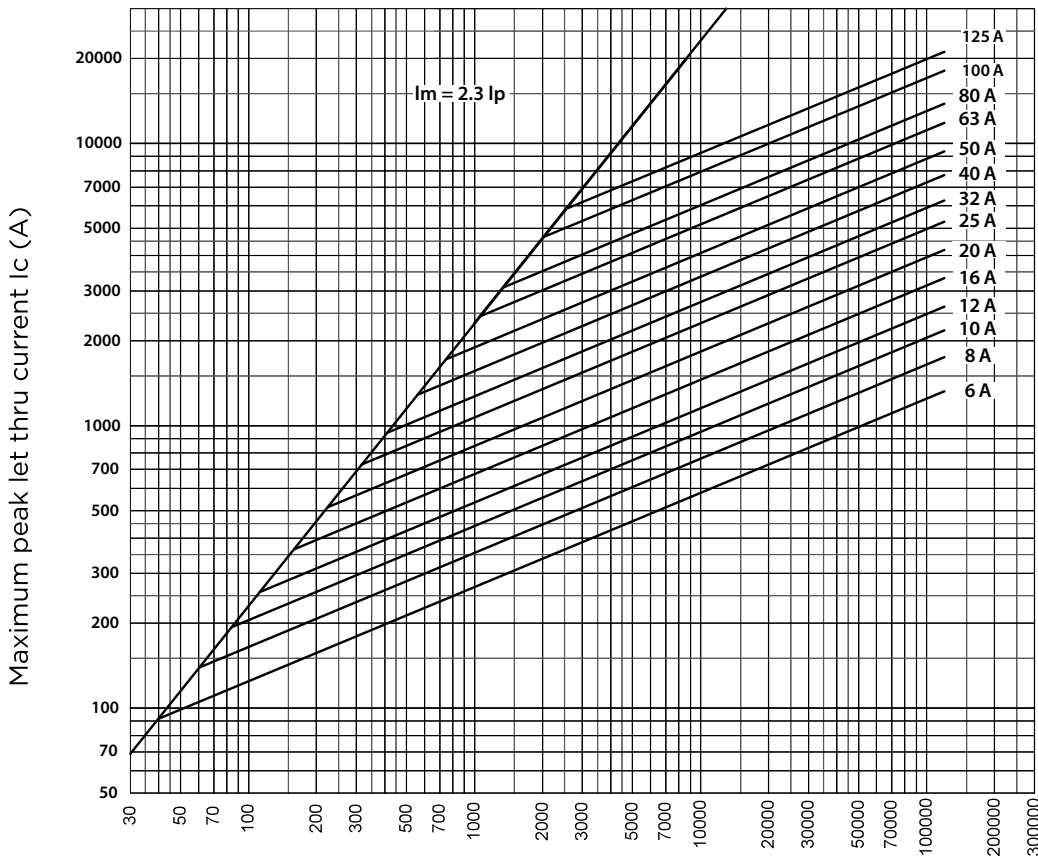
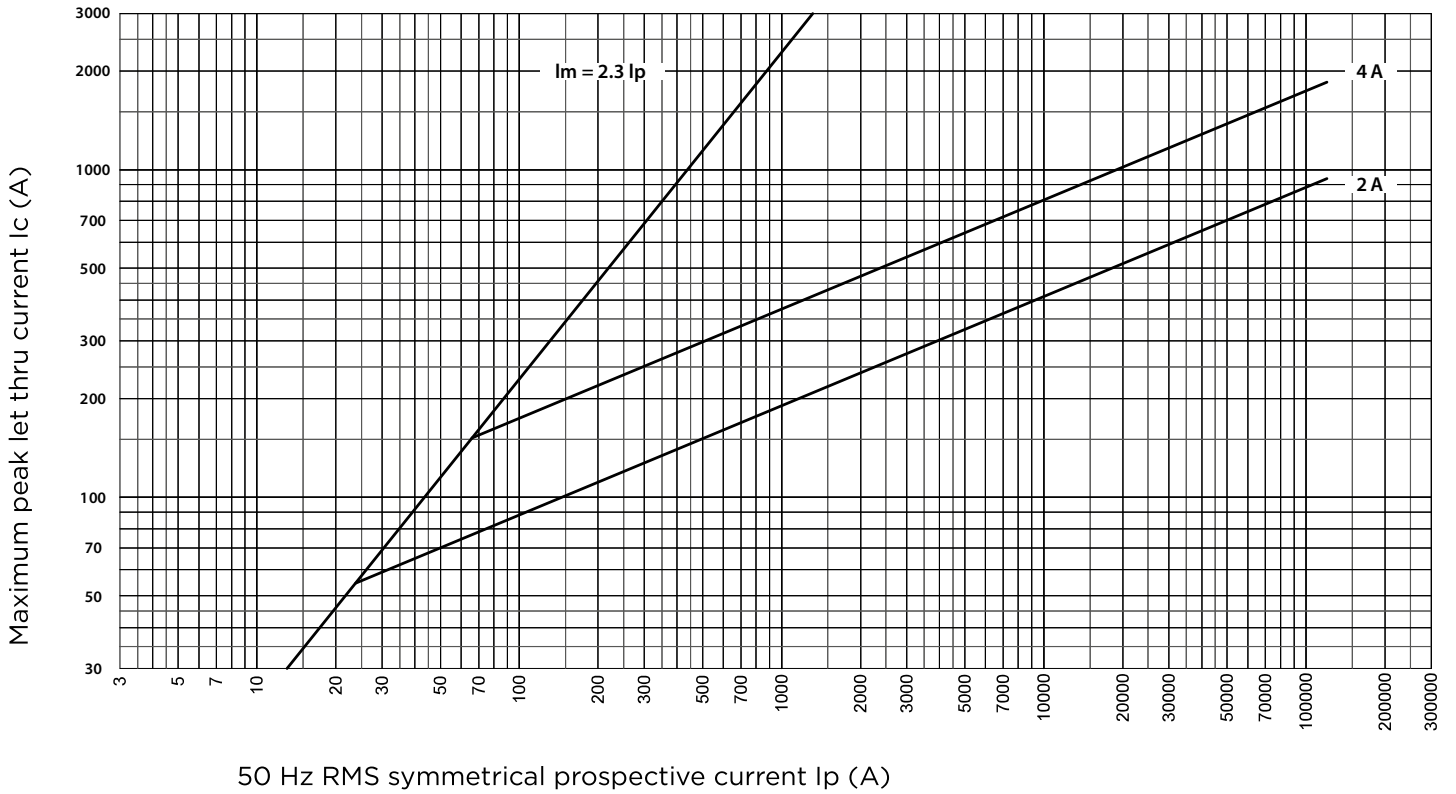

C / Fuse-switch disconnectors for cylindrical fuse-links

Time current characteristics I/t, CH22 aM

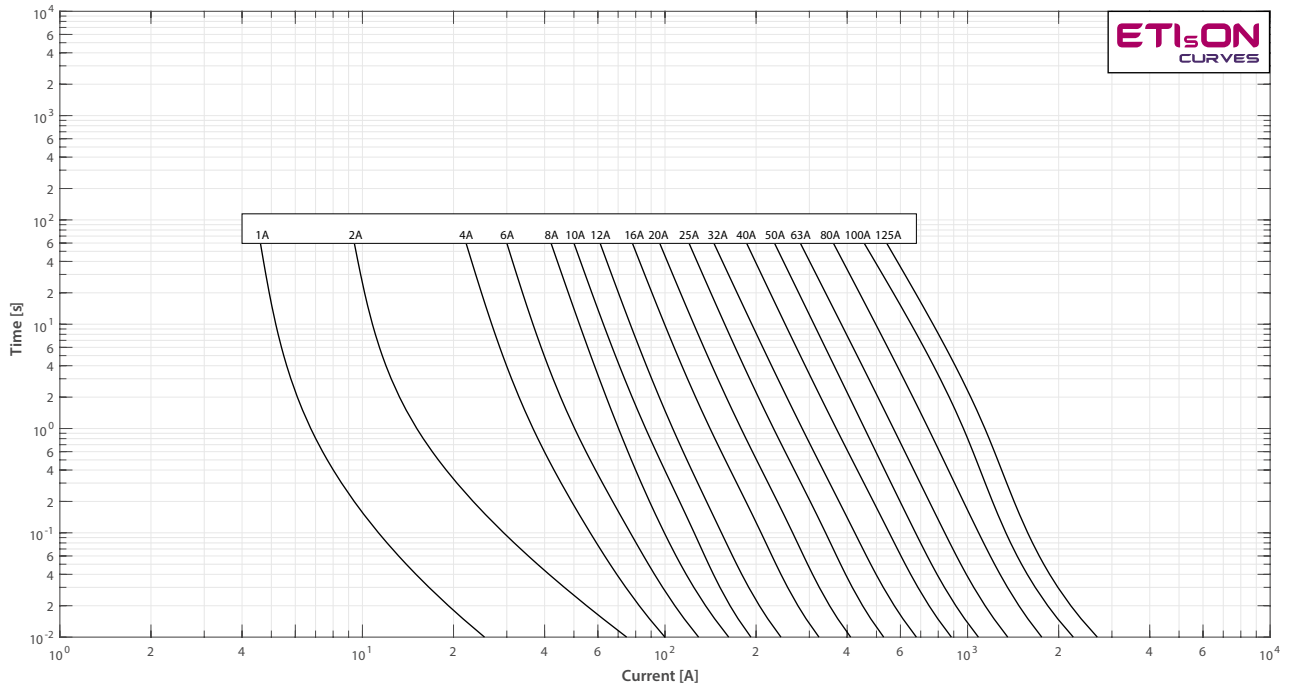

Cut-off current characteristics, CH22 aM

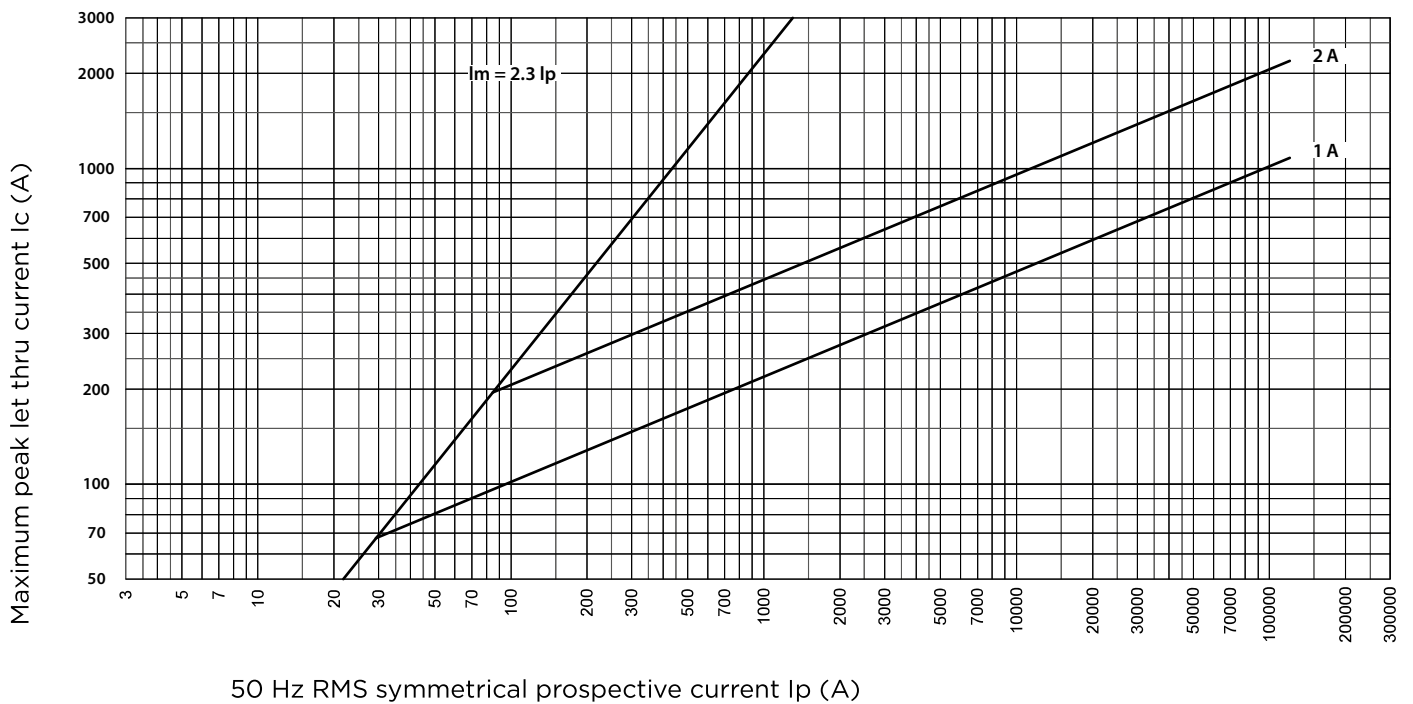

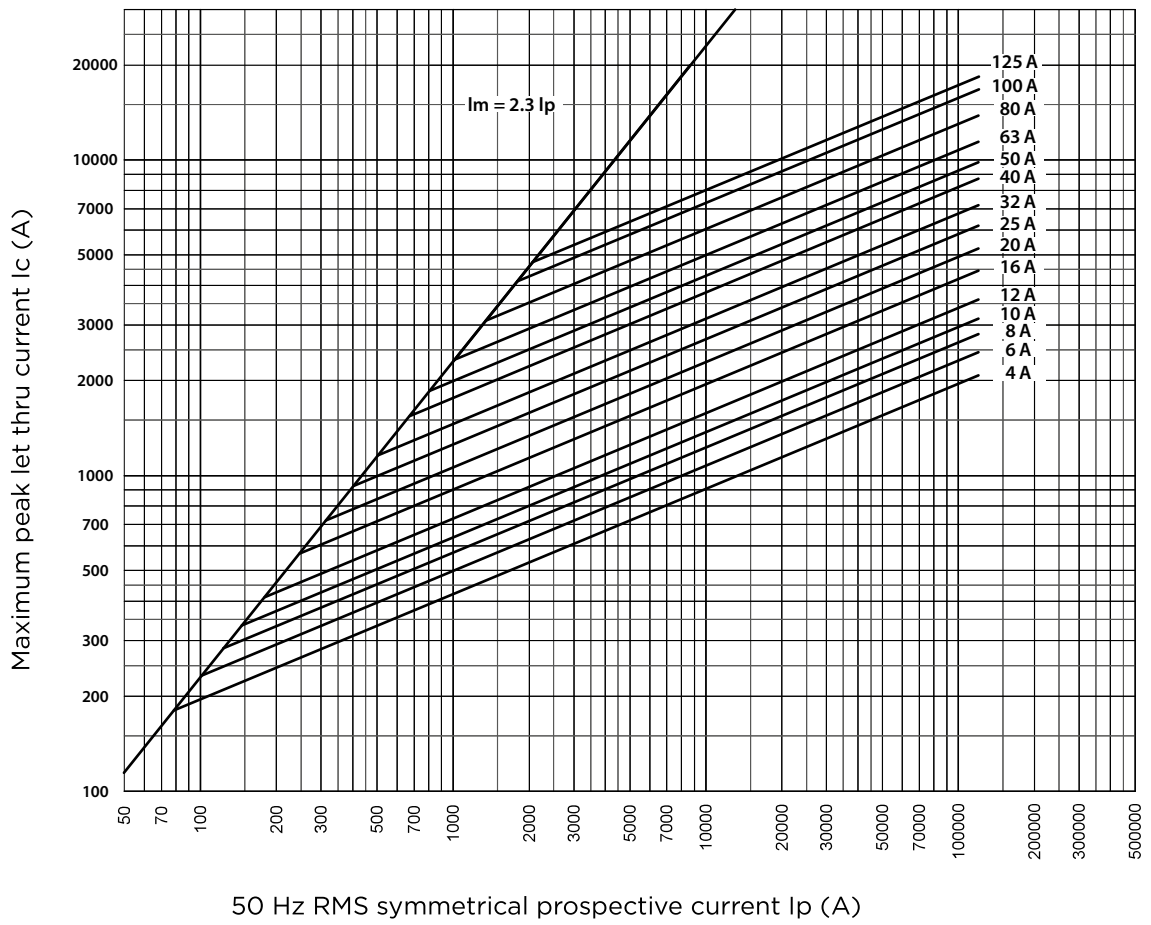

C Fuse-switch disconnectors for cylindrical fuse-links

Fuse-switch disconnecter PCF

- Extraction of entire fuse-link when changing
- Chamber for spare fuse-link



- 1-pole + N in one module



- LED indicator version



- New method of mounting on the DIN rail and simple replacement

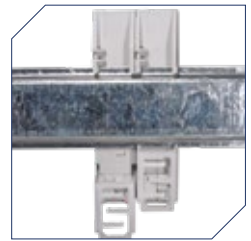

- Double connection clamps



- Sealing possibility



Technical data PCF

	PCF 8	PCF 10
Fuse type	CH 8x32	CH 10x38
VLC	IEC	IEC UL
Versions	Without indicator / LED indicator	
Number of poles	1p, 1p+N, 2p, 3p, 3p+N	1p, 2p, 3p
Rated operational voltage Ue	400V a.c.	690V a.c. 600V a.c./d.c.
Rated operational current Ie	20A	32A 30A
Maximum rated current of fuselinks	690V	10A gG
	500V	25A gG, 16A aM
	400V	20A gG, 10A aM 32A gG
Rated frequency	50Hz	50Hz 60Hz
Rated short-time withstand current Icw	240A	300A
Rated conditional short-circuit current	50kA	100kA 200kA
Rated insulation voltage Ui	400V	690V
Rated imp. withstand voltage Uimp	4kV	4kV
Overvoltage category	III	III
Max power dissipation of the fuse-link (W)	gG: 2,5W / aM: 0,9W	gG: 3W / aM: 1,2W
LED indicator operating range	50V-690V a.c.	
Utilization category	AC-22B	AC-22B Do not operate under load
Operational performance (cycles with current)	300	300
Operational performance (cycles without current)	1700	1700
Humidity	90% at 20°C	
Operating ambient temperature	-5°C ... +40°C	
Store ambient temperature	-25°C ... +55°C	
Degree of protection (IEC 60529)	IP 20	IP 20
Terminal capacity	0,5-10mm ² , Double connection	
Screw	PZ M4	PZ M4 PZ M4
Torque	1,2Nm	1,2Nm 1,2Nm
Mounting on EN 60715 rail	35mm rail	
Sealing possibility	ON and OFF	
Standards - fuse links	IEC/EN 60269-2	
Standards - fuse disconnectors/ fuse holders	IEC 60947-1, IEC 60947-3	UL 4248-1
Test reports	Int.	CCA/CB UL
Certificates	UR _{CS}	

Technical data PCF

	PCF 8	PCF 10
Fuse type	CH 8x32	CH 10x38
	IEC	IEC UL
Derating factor of current I _n for different ambient temperatures	20°	1
	30°	0,95
	40°	0,9
	50°	0,8
	60°	0,7
	70°	0,5
Derating factor of current I _n for side by side mounting fuse holders (nr. of poles)	1-4	1
	5-6	0,8
	7-9	0,7
	≥10	0,6



Fuse-switch disconnecter PCF 8

Rated current
max. 20 A

Rated operational voltage
400V



Utilization category
AC 22B

1-pole

U_e/U_i [V]	I_{max} [A]	Code No.	Indicator		
400	20	002530001	-	58	12/108
		002530011	LED		
		*002531001	-	58	12/108
		*002531011	LED		



*Connection clamp on the right side "French version"

1-pole + N

U_e/U_i [V]	I_{max} [A]	Code No.	Indicator		
400	20	002530002	-	70	12/108
		002530012	LED		
		*002531002	-	70	12/108
		*002531012	LED		



*Connection clamp on the right side, N pole on the left "French version"

2-pole

U_e/U_i [V]	I_{max} [A]	Code No.	Indicator		
400	20	002530003	-	120	6/54
		002530013	LED		
		*002531003	-	120	6/54
		*002531013	LED		



*Connection clamp on the right side "French version"

3-pole

U_e/U_i [V]	I_{max} [A]	Code No.	Indicator		
400	20	002530004	-	180	4/36
		002530014	LED		
		*002531004	-	180	4/36
		*002531014	LED		

*Connection clamp on the right side "French version"

3-pole + N

U_e/U_i [V]	I_{max} [A]	Code No.	Indicator		
400	20	002530005	-	195	4/36
		002530015	LED		
		*002531005	-	195	4/36
		*002531015	LED		

*Connection clamp on the right side, N pole on the left "French version"





Fuse-switch disconnecter PCF 10

Rated current
max. 32 A

Rated operational voltage
690V

Utilization category
AC 22B



1-pole

U_c/U_i [V]	I_{max} [A]	Code No.	Indicator		
690	32	002550001	-	58	12/108
		002550011	LED		
		*002551001	-	58	12/108
		*002551011	LED		

*Connection clamp on the right side "French version"





1-pole + N

U_c/U_i [V]	I_{max} [A]	Code No.	Indicator		
400/690	32	002550002	-	70	12/108
		002550012	LED		
		*002551002	-	70	12/108
		*002551012	LED		

*Connection clamp on the right side, N pole on the left "French version"





2-pole

U_c/U_i [V]	I_{max} [A]	Code No.	Indicator		
690	32	002550003	-	120	6/54
		002550013	LED		
		*002551003	-	120	6/54
		*002551013	LED		

*Connection clamp on the right side "French version"





3-pole

U_c/U_i [V]	I_{max} [A]	Code No.	Indicator		
690	32	002550004	-	180	4/36
		002550014	LED		
		*002551004	-	180	4/36
		*002551014	LED		

*Connection clamp on the right side "French version"



3-pole + N

U_c/U_i [V]	I_{max} [A]	Code No.	Indicator		
690	32	002550005	-	195	4/36
		002550015	LED		
		*002551005	-	195	4/36
		*002551015	LED		

*Connection clamp on the right side, N pole on the left "French version"

C / Fuse-switch disconnectors for cylindrical fuse-links

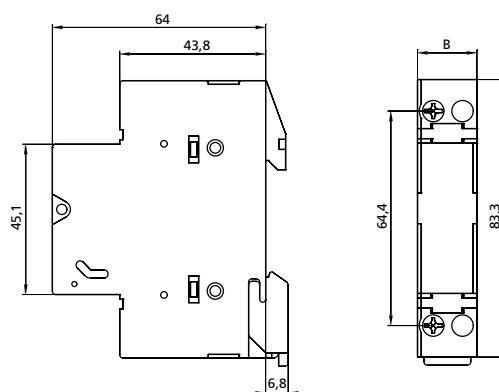

Fuse-switch disconnector PCF 8, PCF 10

type	dimension B [mm]
PCF 8, 10 1p	17,8
PCF 8, 10 1p+N	17,8
PCF 8, 10 2p	35,6
PCF 8, 10 3p	53,4
PCF 8, 10 3p+N	53,4



Accessories

Auxiliary switch PS PCF

U _n [V]	I _n [A]	Code No. PCF8	Code No. PCF10	 g	 1/10	Contact
230	6	002559001	002559001	35	1/10	1 x b 1 x a/b

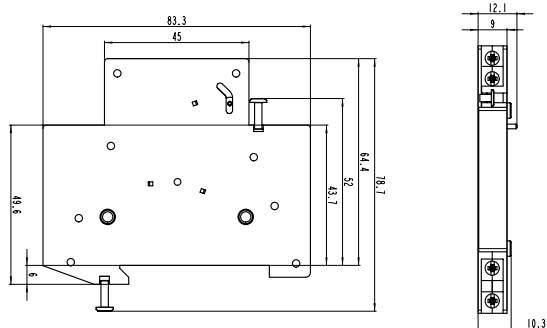

Fuse-switch disconnecter EFD

- Modular design – it is possible to assemble multi-pole versions at the building site for EFD 8, EFD 10, EFD 14 and EFD 22



- All plastic parts are made of material resistant to extremely high temperatures. Fuse carrier assures that a fuse link is not in touch with a housing



- All contact surfaces are silver plated



- For all sizes a version with electronic indicator is available. L (LED) with built-in LED diode which blinks after the fuse-link operates. The indicator is capable of operating in conditions of open circuit with minimum capacitance between connection cables. Operating voltage range from 50V to 690V.



- Complete protection against touch according to IP20
- Changing of a fuse-link without danger of direct touch of parts under voltage



- More space for finger to open fuse carrier



- Possibility of sealing in ON or OFF positions

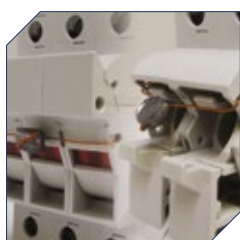

- Compliance with IEC 60947-1, IEC 60947-3, UL 4248-1, UL 4248-4, UL 4248-8 and UL 486E

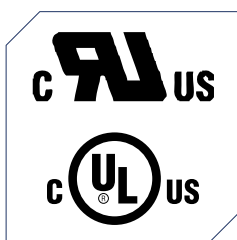

- Mounting on standard DIN 35 mm rail (DIN EN60715). The sizes 22x58 can be also fixed with screws on a flat base

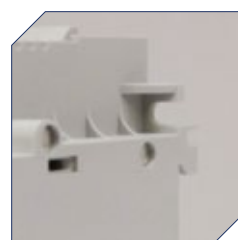

C / Fuse-switch disconnectors for cylindrical fuse-links

Technical data EFD

	EFD 8		EFD 10		EFD CC		EFD 14		EFD 22		EFD J30
Fuse type	CH 8x32		CH 10x38		Class CC		CH 14x51		CH 22x58		Class J, size J30
	IEC	IEC	UL	UL	IEC	UL	IEC	UL	IEC	UL	UL
Versions	Without indicator/LED indicator				Without indicator / LED indicator						
Number of poles	1p, 1p+N, 2p, 3p, 3p+N		1p, 2p, 3p		1p, 1p+N, 2p, 3p, 3p+N		1p, 2p, 3p		1p, 1p+N, 2p, 3p, 3p+N		1p, 2p, 3p
Rated operational voltage U _e	400V a.c.	690V a.c.	600V a.c./d.c.	600V a.c./d.c.	690V a.c.	600V a.c./d.c.	690V a.c.	600V a.c./d.c.	690V a.c.	600V a.c./d.c.	600V a.c./d.c.
Rated operational current I _e	20A	32A	30A	30A	50A	50A	100A	100A	100A	100A	30A
Maximum rated current of fuselinks	690V	10A gG			25A gG 25A aM		50A gG 50A aM		50A gG 50A aM		
	500V	25A gG 16A aM			50A gG		100A gG		100A gG		
	400V	20A gG 10A aM	32A gG		50A aM		100A aM		100A aM		
Rated frequency	50Hz	50Hz	60Hz	60Hz	50Hz	60Hz	50Hz	60Hz	50Hz	60Hz	60Hz
Rated short-time withstand current I _{cw}	240A	300A/1s			600A/1s		1200A/1s		1200A/1s		
Conventional free air thermal current I _{th}					50A		100A		100A		
Rated conditional short-circuit current	50kA	100kA/400V	100kA	200kA	gG: 120kA/500V (50A gG) aM: 50kA/400V (50A aM)	100kA	gG: 120kA/500V (100A gG) aM: 50kA/400V (100A aM)	100kA	100kA	200kA	200kA
Rated insulation voltage U _i	400V	690V			690V		690V		690V		
Rated imp. withstand voltage U _{imp}	8kV	8kV			8kV		8kV		8kV		
Overvoltage category (according to Table H.1 in IEC 60947-1 and according to IEC 60099-1)	III	III			III		III		III		
Max power dissipation of the fuse-link (W)	gG: 2,5W aM: 0,9W	gG: 3W aM: 1,2W		3W	gG: 5W aM: 3W		gG: 9,5W aM: 7W		6W		
LED indicator operating range	50V-690V a.c.		50V - 600V a.c. 80V - 600V d.c.		50V-690V a.c.		50V - 600V a.c. 80V - 600V d.c.		50V-690V a.c.		50V - 600V a.c. 80V - 600V d.c.
NEON indicator operating range	100V-750V a.c.	100V-750V a.c.									
Utilization category	AC-22B	AC-22B	Do not operate under load		AC-22B at 690V/50A	Do not operate under load	AC-21B at 690V/100A	Do not operate under load			
Operational performance (cycles with current)	300	300			300		300		300		
Operational performance (cycles without current)	1700	1700			1700		1700		1700		
Humidity	90% at 20°C				90% at 20°C		90% at 20°C				
Operating ambient temperature	-5°C ... +40°C				-5°C ... +40°C		-5°C ... +40°C				
Store ambient temperature	-25°C ... +55°C				-25°C ... +55°C		-25°C ... +55°C				
Degree of protection (IEC 60529)	IP 20	IP 20			IP 20		IP 20		IP 20		
Terminal capacity	1-25mm ²	1-25mm ²	AWG 18-8 solid&stranded Cu only		1,5-35mm ² rigid or flexible	AWG 16-6 solid&stranded Cu only	4-50mm ² rigid or flexible	AWG 12-2 solid&stranded Cu only			
Screw	PZ M5	PZ M5	PZ M5	PZ M5	PZ M5	PZ M5	PZ M6	PZ M6	PZ M6	PZ M6	PZ M6
Torque	2Nm	2Nm	2Nm; 17,7 lb-in		2,5-3Nm	2Nm; 17,7 lb-in	3Nm	3Nm; 26,6 lb-in			
Mounting on EN 60715 rail	35mm rail										
Sealing possibility	ON and OFF										
Standards - fuse links	IEC/EN 60269-2	IEC/EN 60269-2	IEC/EN 60269-2	UL 248-4 IEC/EN 60269-2	IEC/EN 60269-2	IEC/EN 60269-2	IEC/EN 60269-2	IEC/EN 60269-2	IEC/EN 60269-2	IEC/EN 60269-2	UL 248-8 IEC/EN 60269-2
Standards - Fuse-switch disconnectors/fuse holders	IEC 60947-1 IEC 60947-3		UL 4248-1 UL 4248-4 UL 486E		IEC 60947-1 IEC 60947-3	UL 4248-1 UL 486E	IEC 60947-1 IEC 60947-3	UL 4248-1 UL 486E	IEC 60947-1 IEC 60947-3	UL 4248-1 UL 486E	UL 4248-1 UL 4248-8 UL 486E
Test reports	CCA/CB	CCA/CB	UL	UL	CCA/CB	UL	CCA/CB	UL	CCA/CB	UL	UL
Certificates			UR _{US}	UL _{US}		UR _{US}		UR _{US}		UR _{US}	UL _{US}

Technical data EFD

	EFD 8	EFD 10		EFD CC		EFD 14		EFD 22		EFD J30
Fuse type	CH 8x32	CH 10x38		Class CC		CH 14x51		CH 22x58		Class J, size J30
	IEC	IEC	UL	UL	UL	IEC	UL	IEC	UL	UL
Derating factor of current I_n for different ambient temperatures	20°	1								
	30°	0,95								
	40°	0,9								
	50°	0,8								
	60°	0,7								
	70°	0,5								
Derating factor of current I_n for side by side mounting fuse holders (nr. of poles)	1-4	1								
	5-6	0,8								
	7-9	0,7								
	≥10	0,6								

Fuse-switch disconnecter EFD 8

Rated current **max. 20 A** / Rated operational voltage **400 V** / Utilization category **AC 22B** / For fuse-links size **8x32**

1-pole

U_e/U_i [V]	I_{max} [A]	Code No.	Indicator	Adapter	g	
400	20	002520001	-		63	12/108
		002520011	L-LED		64	
		002520301	-	✓	68	
		002520311	L-LED	✓	69	

1-pole + N

U_e/U_i [V]	I_{max} [A]	Code No.	Indicator	Adapter	g	
400	20	002520002	-		128	6/54
		002520012	L-LED		129	
		002520302	-	✓	138	
		002520312	L-LED	✓	139	
		*002520007	-		128	
		*002520017	L-LED		129	
		*002520307	-	✓	138	
		*002520317	L-LED	✓	139	

*N pole on left "French version"

2-pole

U_e/U_i [V]	I_{max} [A]	Code No.	Indicator	Adapter	g	
400	20	002520003	-		123	6/54
		002520013	L-LED		125	
		002520303	-	✓	134	
		002520313	L-LED	✓	135	



C / Fuse-switch disconnectors for cylindrical fuse-links

3-pole

U_c/U_i [V]	I_{max} [A]	Code No.	Indicator	Adapter	g	
400	20	002520004	-		184	4/36
		002520014	L-LED		186	
		002520304	-	✓	200	
		002520314	L-LED	✓	201	



3-pole + N

U_c/U_i [V]	I_{max} [A]	Code No.	Indicator	Adapter	g	
400	20	002520005	-		252	3/27
		002520015	L-LED		254	
		002520305	-	✓	273	
		002520315	L-LED	✓	274	
		*002520008	-		252	
		*002520018	L-LED		254	
		*002520308	-	✓	273	
		*002520318	L-LED	✓	274	

*N pole on left "French version"

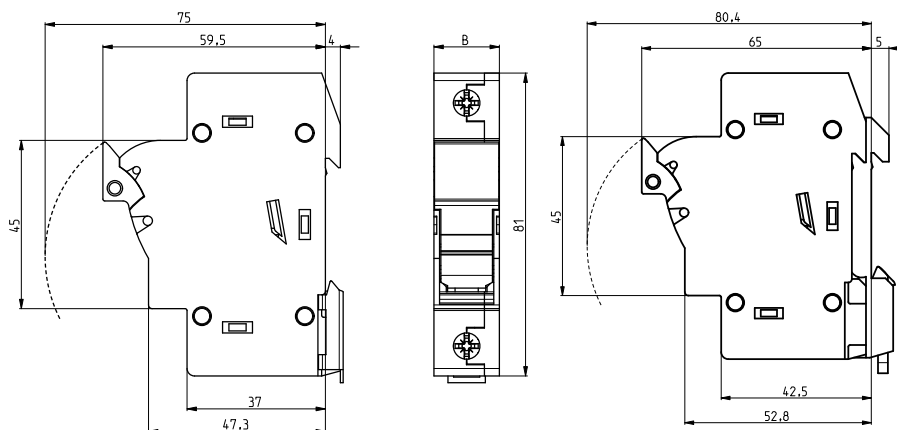

Version with adapter

Fuse-switch disconnecter EFD 8

type	dimension B
EFD 8 1p	17,5
EFD 8 1p+N	35
EFD 8 2p	35
EFD 8 3p	52,5
EFD 8 3p+N	70

Fuse-switch disconnecter EFD 10



Rated current
max. 32 A

Rated operational voltage
690 V



Utilization category
AC 22B

For fuse-links size
10x38

1-pole



U_c/U_i [V]	I_{max} [A]	Code No.	Indicator	Adapter	 g	
690	32	002540001	-		63	12/108
		002540011	L-LED		64	
		002540301	-	✓	68	
		002540311	L-LED	✓	69	

1-pole + N



U_c/U_i [V]	I_{max} [A]	Code No.	Indicator	Adapter	 g	
400/690	32	002540002	-		128	6/54
		002540012	L-LED		129	
		002540302	-	✓	138	
		002540312	L-LED	✓	139	
		*002540007	-		128	
		*002540017	L-LED		129	
		*002540307	-	✓	138	
		*002540317	L-LED	✓	139	

*N pole on left "French version"

2-pole

U_c/U_i [V]	I_{max} [A]	Code No.	Indicator	Adapter	 g	
690	32	002540003	-		123	6/54
		002540013	L-LED		125	
		002540303	-	✓	134	
		002540313	L-LED	✓	135	



3-pole

U_c/U_i [V]	I_{max} [A]	Code No.	Indicator	Adapter	 g	
690	32	002540004	-		184	4/36
		002540014	L-LED		186	
		002540304	-	✓	200	
		002540314	L-LED	✓	201	



C / Fuse-switch disconnectors for cylindrical fuse-links

3-pole + N

U_e/U_i [V]	I_{max} [A]	Code No.	Indicator	Adapter	 g	
690	32	002540005	-		252	3/27
		002540015	L-LED		254	
		002540305	-	✓	273	
		002540315	L-LED	✓	274	
		*002540008	-		252	
		*002540018	L-LED		254	
		*002540308	-	✓	273	
		*002540318	L-LED	✓	274	

*N pole on left "French version"

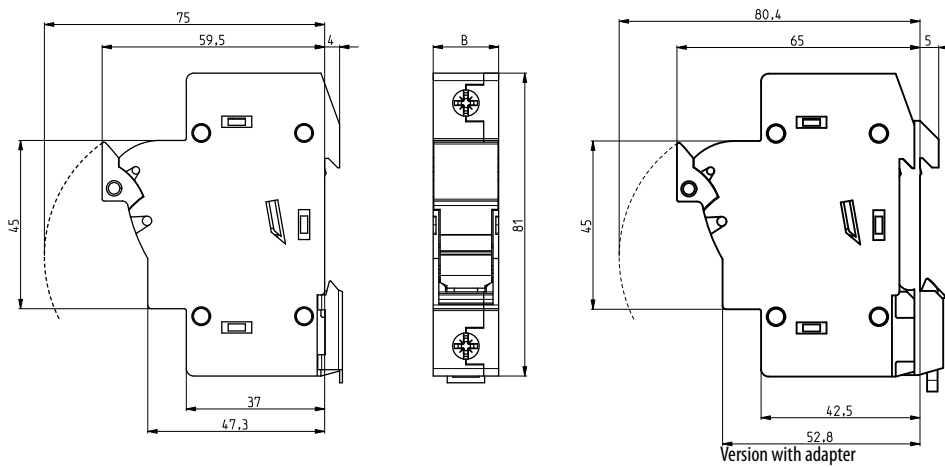

Fuse-switch disconnector EFD 10

type	dimension
	B
EFD 10 1p	17,5
EFD 10 1p+N	35
EFD 10 2p	35
EFD 10 3p	52,5
EFD 10 3p+N	70

Fuse-switch disconnecter EFD CC

Rated current
max. 30 A

Rated operational voltage
600 V

For fuse-links
Class CC acc to UL4248-4

1-pole

U_e/U_i [V]	I_{max} [A]	Code No.	Indicator	Adapter	g	
600	30	002540101	-		63	12/108
		002540111	L-LED		64	
		002540401	-	✓	68	
		002540411	L-LED	✓	69	

2-pole

U_e/U_i [V]	I_{max} [A]	Code No.	Indicator	Adapter	g	
600	30	002540103	-		123	6/54
		002540113	L-LED		125	
		002540403	-	✓	134	
		002540413	L-LED	✓	135	

3-pole

U_e/U_i [V]	I_{max} [A]	Code No.	Indicator	Adapter	g	
600	30	002540104	-		184	4/36
		002540114	L-LED		186	
		002540404	-	✓	199	
		002540414	L-LED	✓	201	

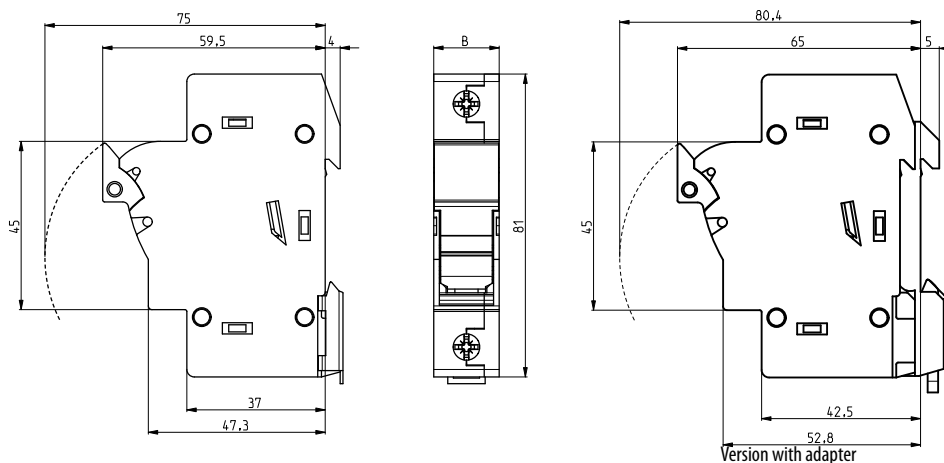

Fuse-switch disconnecter EFD CC

type	dimension
B	
EFD CC 1p	17,5
EFD CC 2p	35
EFD CC 3p	52,5

Fuse-switch disconnecter EFD 14



Rated current
max. 50 A

Rated operational voltage
690 V



Utilization category
AC 22B

For fuse-links size
14x51

1-pole



U_c/U_i [V]	I_{max} [A]	Code No.	Indicator	 g	
690	50	002560001	-	102	12/96
		002560011	L-LED	103	

1-pole + N



U_c/U_i [V]	I_{max} [A]	Code No.	Indicator	 g	
690	50	002560002	-	226	6/48
		002560012	L-LED	227	
		*002560007	-	226	
		*002560017	L-LED	227	

*N pole on left "French version"



2-pole

U_c/U_i [V]	I_{max} [A]	Code No.	Indicator	 g	
690	50	002560003	-	206	6/48
		002560013	L-LED	208	

3-pole

U_c/U_i [V]	I_{max} [A]	Code No.	Indicator	 g	
690	50	002560004	-	310	4/32
		002560014	L-LED	313	

3-pole + N

U_c/U_i [V]	I_{max} [A]	Code No.	Indicator	 g	
690	50	002560005	-	434	3/24
		002560015	L-LED	437	
		*002560008	-	434	
		*002560018	L-LED	437	

*N pole on left "French version"



Fuse-switch disconnecter EFD 14

type	dimension
	B
EFD 14 1p	27
EFD 14 1p+N	54
EFD 14 2p	54
EFD 14 3p	81
EFD 14 3p+N	108

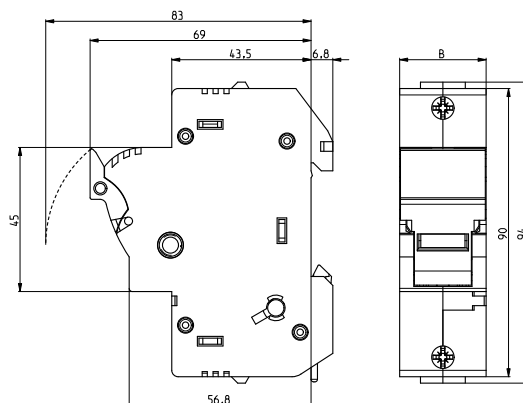

Fuse-switch disconnecter EFD 22

For fuse-links size
22x58

Rated current
max. 100 A

Rated operational voltage
690 V

Utilization category
AC 21B

1-pole

U_e/U_i [V]	I_{max} [A]	Code No.	Indicator	g	Box
690	100	002570001	-	156	3/105
		002570011	L-LED	158	

1-pole + N

U_e/U_i [V]	I_{max} [A]	Code No.	Indicator	g	Box
690	100	002570002	-	351	2/48
		002570012	L-LED	353	
		*002570007	-	351	
		*002570017	L-LED	353	

*N pole on left "French version"

2-pole

U_e/U_i [V]	I_{max} [A]	Code No.	Indicator	g	Box
690	100	002570003	-	317	2/48
		002570013	L-LED	321	

3-pole

U_e/U_i [V]	I_{max} [A]	Code No.	Indicator	g	Box
690	100	002570004	-	476	1/35
		002570014	L-LED	485	



C / Fuse-switch disconnectors for cylindrical fuse-links

3-pole + N

U_e/U_i [V]	I_{max} [A]	Code No.	Indicator	Weight [g]	Packaging [pcs]
690	100	002570005	-	671	1/24
		002570015	L-LED	677	
		*002570008	-	671	
		*002570018	L-LED	677	

*N pole on left "French version"



Fuse-switch disconnecter EFD 22 & EFD J30

type	dimension B
EFD 22, J30 1p	35,6
EFD 22 1p+N	71,2
EFD 22, J30 2p	71,2
EFD 22, J30 3p	106,8
EFD 22 3p+N	142,4

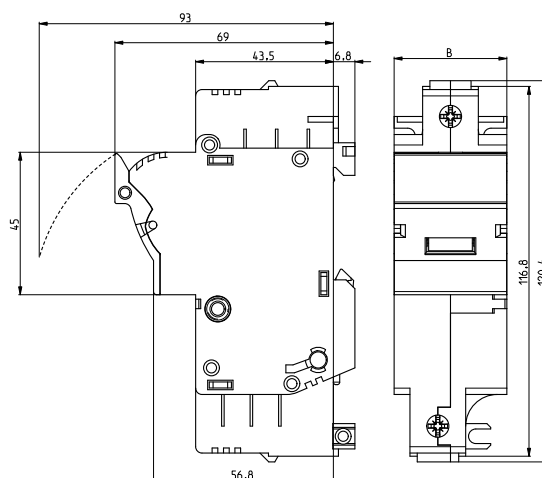

Fuse-switch disconnecter EFD J30

Rated current
max. 30 A

Rated operational voltage
600 V

For fuse-links
Class J acc to UL4248-8

1-pole

U_e/U_i [V]	I_{max} [A]	Code No.	Indicator	Weight [g]	Packaging [pcs]
600	30	002570101	-	156	3/105
		002570111	L-LED	158	

2-pole

U_e/U_i [V]	I_{max} [A]	Code No.	Indicator	Weight [g]	Packaging [pcs]
600	30	002570103	-	317	2/48
		002570113	L-LED	321	

3-pole



U_e/U_i [V]	I_{max} [A]	Code No.	Indicator	Weight [g]	Packaging [pcs]
600	30	002570104	-	476	1/35
		002570114	L-LED	485	



Accessories



Auxiliary switch PS EFD is intended to be mounted with disconnectors EFD 14 and EFD 22 for all versions (1p, 2p, 1p+N, 3p, 3p+N). The width of apparatus is 9 mm, other dimensions comply with EFD 14 and EFD 22 series switches. Auxiliary switch PS EFD signals the operation of CH14 or CH 22 fuse-links only in the case a fuse-link is fitted with striking pin - see IEC 60 269-2 Figure 1a (III).

Auxiliary switch PS EFD

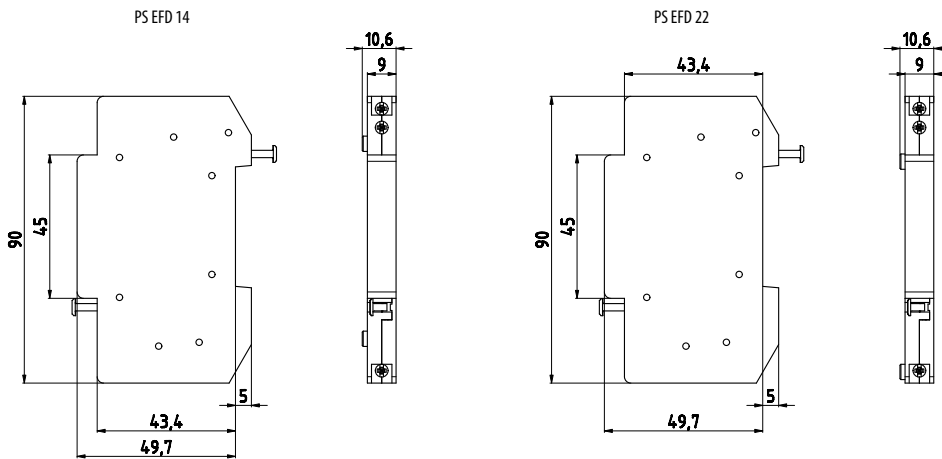
U _n [V]	I _n [A]	Code No. EFD14	Code No. EFD22	 g		Contact
250	5	002569001	002579001	50	1/10	1 x make 1 x break



Connection kit

Description	Code No.	For use with	 g	
Connection kit 2p	002540948	EFD 8, EFD 10, EFH 10, PCF 8, PCF 10	96	1*/20
Connection kit 3p	002540949	EFD 8, EFD 10, PCF 8, PCF 10	162	1*/20
Connection kit 2p	002560948	EFD 14, EFH 14	144	1*/20
Connection kit 3p	002560949	EFD 14	217	1*/20
Connection kit 2p	002570948	EFD 22, EFD J30	191	1*/20
Connection kit 3p	002570949	EFD 22, EFD J30	300	1*/20

*Note: 1 kit suffices for the assembly of 50 sets



