

# ETI UTRIP

ETI group journal | ISSN 1580-4879

QUIP PROTECTIO  
INDUSTRY

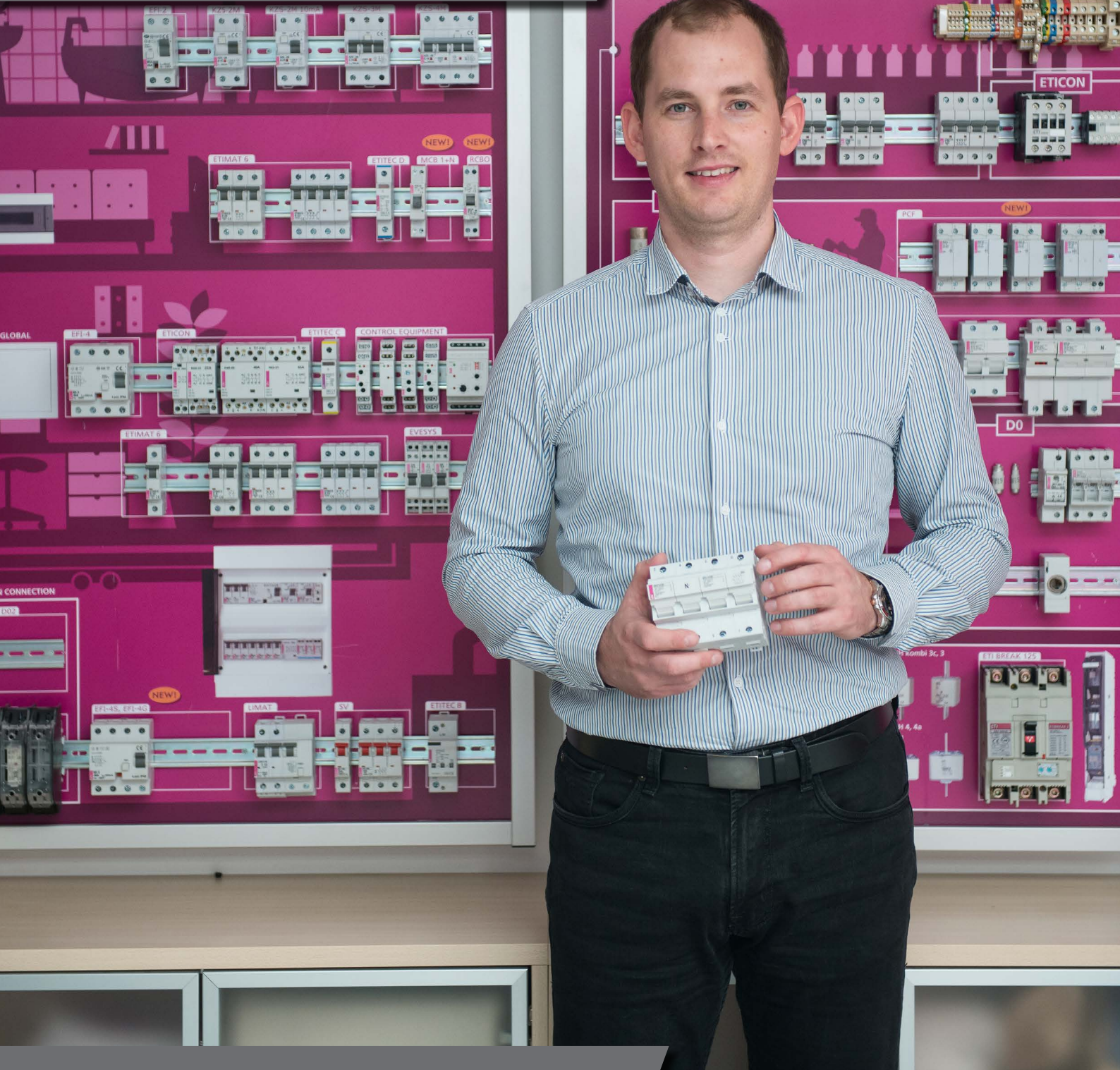

- ETI is Best Slovenian Factory of 2021
- Industry 4.0 at ETI
- Responsibility and solidarity in ETI group during COVID-19





## Index

Highlights from 2021 .....	3
ETI Has Been Declared Best Slovenian Factory of 2021 .....	4
ETI's innovators awarded silver at National CCIS Innovation Day 2021 .....	6
Government of Republic of Slovenia's visit to ETI's headquarters .....	7
ETI Software Support .....	8
Introduction to FuseSpline .....	9
Control and protection, Dom 24 h – the smart home of the future for a comfortable and healthy living and working environment .....	10
Industry 4.0 at ETI .....	11
New automatic production line for NV1 and NV2C fuse links .....	12
Update of the FI relay process .....	14
Interview with Kristijan Vlašić, the new director of ETI Croatia .....	16
Daniel Hochrein, the new General Manager of ETI ET Deutschland .....	17
»Looking for Bright Minds« campaign brings record number of applications for scholarships .....	18
Responsibility and solidarity - the guiding principle of the ETI Group during COVID-19 .....	20
Getting Healthy with Exercise – Hiking .....	21
Beautiful Zasavje, ETI's homeplace .....	23

Sabina Pešec

# Highlights from 2021

## Solidarity during the corona crisis

At ETI, we have tackled the covid crisis on all fronts. In Slovenia as well as in other countries of the group, we participated in several different charity campaigns, such as the purchase of respirators for the Trbovlje General Hospital, the purchase of specialized beds for intensive care patients for the Pultusk Hospital, the purchase of computer equipment for school kids in Zasavje and much more. Our employees also helped as volunteers at the Izlake Home for the Elderly and the Trbovlje General Hospital. Help was extended within the ETI group, both by sharing protective equipment and exchanging knowledge and experience with measures to prevent the spread of infection. At the end of the year, we can conclude that these were timely and well executed, and that, thanks to the responsible conduct of each of us, we did not have to stop production and operations for even one day.

## ETI's switchgear production renovation cycle is coming to a close

As part of the process of renewal of our switchgear production, a decision was made to renovate the process of manufacturing FI relays. These are a very demanding component of the EFI RCCB, which ensures its functionality - switching off at a certain differential current. The next and last step of our 3-year switchgear production renewal cycle is the new ETIMAT automated production line, which will be finished next year.

## ETI Prostik has designed the protection of electrical installations in the smart home of the future

A consortium of 12 Slovenian companies including ETI developed a project of a smart home of the future. Home 24 h provides comprehensive electrically, thermally and information self-sufficiency for a living and working environment. In this project, ETI group provided products for protection and control of electrical installations, including the brand new RCBO KZS 1M EM with built-in electricity meter with appropriate transmission to the IT environment, and designed the entire electrical protection and control of the facility.

## ETI is ready for BIM

ETI follows modern guidelines in the field of support for users of our products. One of them is definitely design using BIM (Building Information Modelling) technology. Although, unlike in the field of architecture, electro BIM design is developing more slowly and it is not yet clear what the BIM model of our device will contain, we at ETI are ready for this transition. We are rapidly digitizing our products, both with data and 3D models, and some of them already contain more than 30 different parameters. At the same time, all this information is always available to the user on our website.



## ETI Proplast completes a series of renovations in the production of NH fuse-links

This year, the third and most demanding automatic production line of NH fuse-links, manufactured for the parent company by ETI Proplast, was completed. This renewal was crucial for achieving lower own product prices and increasing production capacity. At the same time, in this way we also achieved unification with production in ETI Polam and the transition to an exclusively KOMBI version of fuse-links. All of this will allow us to further grow our market share and the profitability of the entire NH program.

## ETI is Slovenian Factory of 2021

In the autumn, ETI became the Slovenian Factory of 2021. This is the award given by the Finance newspaper in which all the largest technology companies in the country participate. You can read more about this on the following pages.





Gregor Ceglar, Sabina Pešec

## ETI Has Been Declared

# Best Slovenian Factory of 2021

In October, the selection of the best Slovenian factory of the year, organized by one of the leading Slovenian newspapers Finance in cooperation with KPMG auditing company, took place. This competition aims to give recognition to people in Slovenian factories for their achievements and contribution to the prosperity of our country. By winning this year's award, ETI joined a group of technologically advanced companies such as the pharmaceutical giant Krka and BSH Nazarje. At the same time, we were also ranked among the top three engineering and development teams in 2021.

The goals of the Factory of the Year award are to emphasize good practice in factories that contribute to higher added value and greater competitiveness of our companies in domestic and foreign markets and to raise awareness of the importance and achievements of Slovenian manufacturing companies in the general public. The Factory of the Year Award recognizes the technological advancement of manufacturing companies and their ability to implement new, advanced technologies and processes, thus increasing their revenues and productivity and profits.

The process of review and analysis of candidates is quite demanding, both for the organizer and for the candidates, as the prestige of this award demands. Applicants must first complete a very detailed questionnaire covering key performance indicators of the company, technological advancement of production, concern for sustainable development (environment) and concern for employees. KPMG then fills out questionnaires to assess the five-point scales, in accordance with the methodology for assessing the maturity of individual business are-

as, based on the evaluated questionnaires among companies to make a shortlist.

In the next step, the KPMG expert team also visits the best of these companies, to learn more about

good practices that were presented in the filled-out questionnaires by conducting interviews with experts from various fields responsible for production, IT, implementation of industry 4.0 principles,





digitization, development. . . This year, the KPMG team shortlisted 5 companies. We hosted the KPMG team on 13th July 2021. The presentation of the company was followed by a tour of the production and a discussion / interview between our and their team, where our practices were presented in more detail. All companies received feedback about their results compared to the average (see Figure).

In the next step, KPMG in collaboration with the editorial team of the Factory of the Year project selected 3 finalists – these were, in addition to ETI, DANFOSS TRATA and ETA CERKNO. The final decision on who is the winner, based on the presentations of the finalists and a public hearing at the final event of the selection is made by a four-member expert commission. This year, the members of the expert commission were Anton Papež, an experienced manager who was also the commission's chairman, Sibil Svilan, chairman of the board of SID Bank, Stane Merše, head of the Center for Energy Efficiency at the Jožef Stefan Institute, and representative of the Factory of the Year 2020, Matija Petrin, technical director in BSH Home Appliances Nazarje. The final event took place at the Nazarje Cultural Centre, where the 2020 winner (BSH Hišni aparati Nazarje) hosted the finalists and other attendees. After the presentations, all attendees went to BSH production premises, where we were introduced to their production processes. In the meantime, the expert committee deliberated on the basis of assessments and final presentations, and announced... that the Factory of the Year 2021 is ETI, d.o.o.! An excellent feeling, validation of our good work, and immense joy for our team.

Yet this is only another stage in our development process. Our gaze is already turned forward, towards the future... Today, technologies offer many solutions that will help bring the company to a higher level and help us become even more successful. In the end, with all the technologies, methods, automation, digitization, LEAN, Industry 4.0. . . , one fact remains unchanged: the person – our employee – and our teams are key to any success. The technology (system, method) is necessary but useless without the collaboration with the user. And all this technology only provides assistance; people are and always will be essential.

And last but not least, this year, the selection of the Factory of the Year award was supplemented with another award - the selection of the engineering and development team of the year, intended to give special recognition to the team of engineers, developers and other profiles from production. The three finalists were chosen by the editorial board of the Factory of the Year from among the companies participating in the selection for the best production company, and the best engineering and development team of the year is chosen by voting by representatives of companies that have participated in previous competitions. ETI contended with our new NH MET-COM fuse-link and EFI automatic production line and was selected as one of the best three.

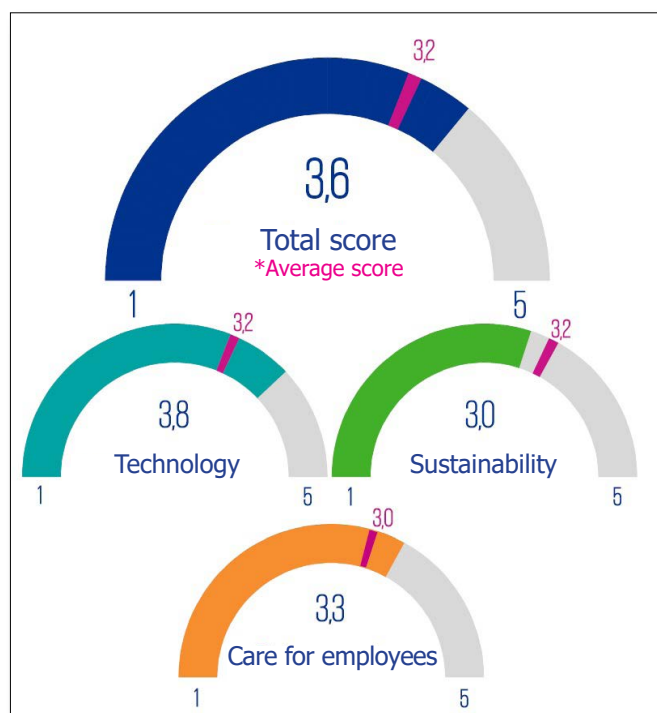



Miran Dolinšek

## ETI's innovators awarded silver

# at National CCIS Innovation Day 2021

At this year's Innovation Day, ETI's new EFI-P automatic assembly line and the new generation of HV medium-voltage fuse-links competed for the national awards from the Chamber of Commerce and Industry of Slovenia (CCIS). Both received silver awards.

In October, the Chamber of Commerce and Industry of Slovenia organized the event Innovation Day 2021, which consisted of a conference dedicated to innovations of Slovenes around the world and the 19th awarding of national CCIS awards for innovation. Out of 207 innovations that applied at regional chambers of commerce this year, 41 best golden regional innovations competed for the highest national awards of the Chamber of Commerce and Industry for innovations at the national level. ETI's innovators received two silver awards for innovation this year:

### Industrialization of the new generation EFI-P

Innovators: Miran Dolinšek, Blaž Pleterski, Franci Smrkolj, Tadej Drnovšek, Bernie Bezenšek, Urban Majdič, Jože Majdič (ETI Elektroelement)

Alfio Krivičič, Boštjan Domijan, Gregor Kuštrin, Egon Hreščak, Tomaž Boštjančič, Franci Volarič (HIDRIA d.o.o. IA Competence Center)

Companies: ETI Elektroelement d.o.o. and HIDRIA d.o.o. IA Competence Center

Short description: The automatic assembly line is the result of the development of assembly and control process technology adapted to the new EFI-P2 and EFI-P4 residual current circuit breakers. The assembly and control process is almost entirely automatic. In the assembly process, all input material and assembly processes are 100% controlled.

and

### New generation of HV fuse-links

Innovators: Uroš Kovač, Miha Medved, Viktor Martinčič

Companies: ETI Elektroelement d.o.o. and RC eNeM d.o.o.

Short description: The new generation of medium-voltage fuse-links with completely renewed melting elements and thermal striker pin ensures the best ratio between power dissipation and minimum breaking capacity on the market, rational material consumption and optimized I / t characteristics.



*Congratulations to all the innovators!*



Sabina Pešec

# Government of Republic of Slovenia's visit to ETI's headquarters

ETI Elektroelement was visited by Slovenian government twice this year. First in the spring by the Minister of Economic Development and Technology Zdravko Počivalšek and later in autumn by the Minister of foreign affairs dr. Anže Logar. Both government officials were presented the new, fully automated production line of ETI's EFI-P RCCBs, got acquainted with the group's outstanding business results and presented new government initiatives to subsidize companies' investments in technology and digitalization.





Klemen Sitar

# ETI Software Support

Data about software tools used by our clients is essential to ETI, as it serves as the basis for developing quality tools and libraries to simplify work and provide digital access to various information that you need about our products. We dedicate much of our time and efforts to preparing quality databases, adding 2D/3D models to our products, optimizing our website, and developing various freeware (you can access the website about our software by scanning the QR code on the right).

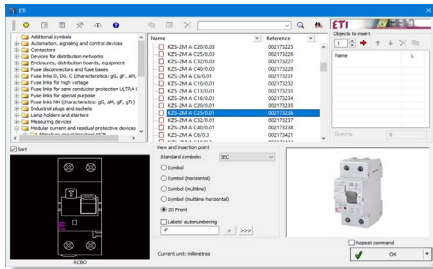

**ETICAD:**

ETICAD is an interface with a symbol library of our products for designers (for various CAD software: AUTOCAD, ZWCAD, BRICSCAD, GSTARCAD, PROGECAD, ARES CAD, etc.) The library includes over 14,000 products and is available in multiple languages. Products in ETICAD include many technical data, while its primary advantage is simple and quick insertion of 2D views or symbols for the desired products. The QR code on the right contains a link to the ETICAD presentation video.



**EPLAN:**

ETI also regularly upgrades the library for EPLAN. EPLAN is the leading tool on the global market for developing electric, fluid, and pneumatic schematics, for drawing enclosures and wiring looms in 3D, and for planning industrial processes. Currently, our EPLAN library includes more than 6,000 products. The EPLAN data standard has already been implemented for the majority of these products, meaning that the quality of data was verified by EPLAN.

Data include schematic macro, 2D and 3D macro, defined connection points, location of drilling holes, and many other data about the products. All of this is translated into 11 different languages (en, de, ru, pl, cz, hu, si, sk, hr, ua, ro). The QR code on the right contains a link to the EPLAN presentation video.

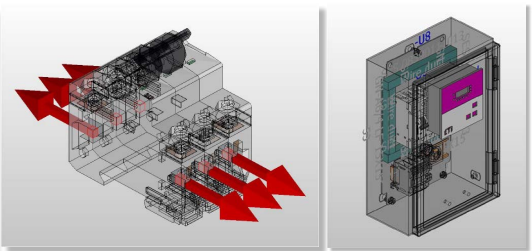
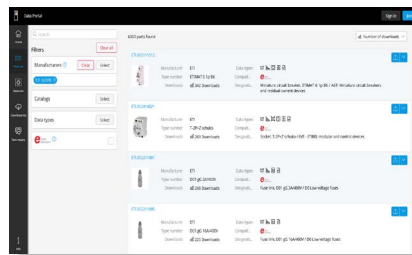

**ETISON:**

ETISON Curves is a convenient and essential software to:

- draw and analyse I/t curves of protection devices;
- adjust and test settings of protection devices' I/t curves, and examine influence of changing the protection curve shape;
- analyse and ensure selectivity between protection devices;
- simulate the response of protection devices in case of an overload or a short circuit;
- define the most suitable protection devices in an electrical circuit in cases when the working points and corresponding limit conditions from real applications are known;
- draw I/t curves of the load response and select the most suitable protection device,
- prepare reports for the inclusion into electrotechnical project documentation, e.g. PZI, PID;
- save project in a special archive format, download and share projects with other users of ETISON Curves.

The QR code on the top contains a link to the ETISON presentation video.

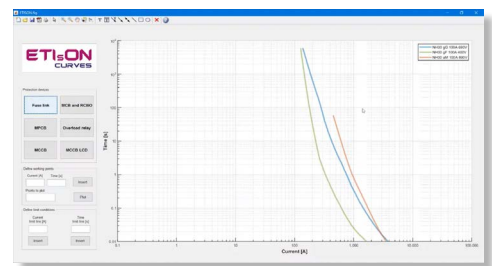

**BIM:**

Due to frequent requests for BIM models, ETI recently started creating its first BIM models. BIM is an acronym for "Building Information Modelling". The main advantage of the BIM model is that our 3D model can also include various collected data about the product. You can see more information in the example of ETI's GT 65-55-20 metal enclosure below.

Our BIM models currently include:

- 3D model
- Basic product data (code, name, product group, product link, short description)
- Contacts (telephone, fax, email)
- Dimensions (depth, height, width)
- ETIM 7.0 Classification
- Logistic data (basic packaging, EAN code)
- Company data (address, country, link to the website)
- Technical data (frequency, characteristic, IP class protection, number of poles, power dissipation, rated current, AC/DC rated voltage, voltage type, mass)

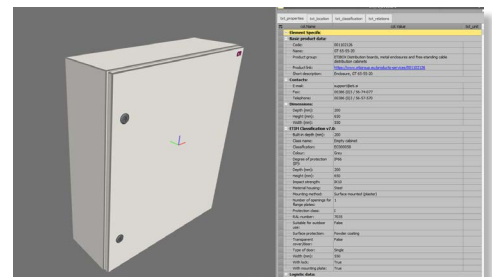



Viktor Martinčič

# Introduction to FuseSpline

This article will introduce a new software tool called FuseSpline that will help users select the right HV fuse link to protect power transformers, motors or compensation batteries.

The process of selecting the correct protective apparatus in electrical installations is very important and must always be carried out professionally. This is especially true in the field of high voltages, i.e. voltages higher than 1000 V.

Part of the product range of ETI, d.o.o. is of course also related to high voltages, as we have been producing fuse links for the protection of high voltage networks for many years, and we have recently introduced a new series of VV fuse links called VVT TD3.

Users of VV fuse links often have a multitude of questions and doubts, and appropriate technical advice is one of the advantages we have built up over the years of our presence on the market.

There are a wide variety of instructions and descriptions in the literature on the correct selection of HV fusing cartridges for the protection of high voltage transformers, motors, compensation batteries and the like. In any case, the use of VV fuse links for the protection of (power) transformers is one of the most common, but in spite of this, many ambiguities and even inaccuracies still occur in practice. Therefore, let me just give some general criteria and procedures for the selection of the »correct« VV fuse link:

- The basic standards defining the technical characteristics of VV fusing elements are IEC 60282-1 and the harmonised German standard VDE 0670-4, but the basic limits of the current-time characteristics for VV fuse links are not defined. This means that the rated currents of VV fuse links from different manufacturers cannot be directly compared with each other. Therefore, the selection of a VV fuse link for use in a particular application can only be based on the manufacturer's data.
- The rated current of the fuses of the VV fuse link is normally substantially higher than the operating current of the protected power transformer and shall generally be equal to twice its rated current. When determining the rated current of the VV fusing element, it is also very important to consider the minimum current, which varies between manufacturers. This is because during normal operation of the power transformer, the VV fuse link must not react.
- Account should be taken of so-called »inrush« currents, possible overload currents of the protected transformer, including the ever present higher harmonic frequency currents, the circuit compensation currents associated with the switching of transformers, motors and capacitors.
- When calculating the correct VV fuse link, the overcurrent and short-circuit protection on the secondary side of the transformer (NV fuse link, MCCB compact circuit breaker or some other type of switchgear combination) must also be taken into account.

From what has been written so far, it can be concluded that the correct selection of a VV fuse link in a particular application requires a great deal of knowledge and expertise in electrical engineering. Add to this the time required in the case of »manual« calculation of the correct protection, and it is logical that any simplification of this procedure is welcome.

One of the ways to reduce the time and simplify the process of selecting a VV fuse link is to use computer applications, of which there are already a number on the market.

The proposal to develop an application adapted to the new VVT TD3 series came a few months ago from Jean Müller, from Mr. Sebastian Eschmann, who at Jean Müller is involved in the introduction of various software applications in their production and sales programme, and we at ETI also thought it was a very good idea and immediately supported it.

Experts from both companies then worked together to develop an application for selecting the right HV fuse link to protect different consumers. The official name of this application is FuseSpline 2.1., and in the following figures I will try to briefly describe the process of determining the »right« HV fuse link for the protection of a specific power transformer.

Example:

We need to determine the correct type of HV fuse link for the protection of a 250 kVA power transformer connected to a 10 kV mains voltage. Select the »Calculation SSK« tab and select the data on the right side of the user window – red arrow in the picture below:

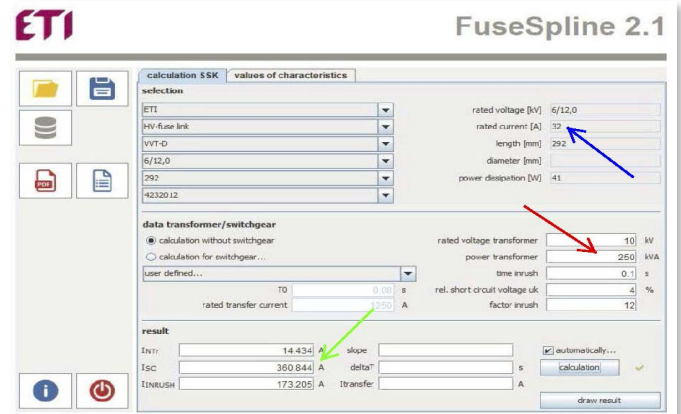

In this window, you can also specify the size of the inrush current, which is usually 12 times the rated current on the primary side but can vary according to the requirements of the individual electricity distribution company.

With the power transformer data selected above, the software calculates the rated current and dimensions of the selected fusing element (blue arrow in the figure above), i.e. 12 kV / 32 A, and the other technical data of this fusing element, including the product code, also appear on the right side of the screen. A detailed calculation of this example is added on the left hand side below – green arrow, showing the calculated rated primary current of 14.434 A, the inrush current of 173.205 A and the short-circuit current of 360.844 A.

If you decide to check the off times of the selected VV fuse link in a little more detail, select the »values of characteristics« tab in the application – see figure below.

We have selected a 24 kV fusing cartridge with a rated current of 63 A, red arrow in the following figure, and in the »data calculation current value«, we enter that we are interested in the current at which the selected fuse link would switch off in 5 seconds. The result is displayed in the bottom left of the screen and the current entered here is 287.338 A.

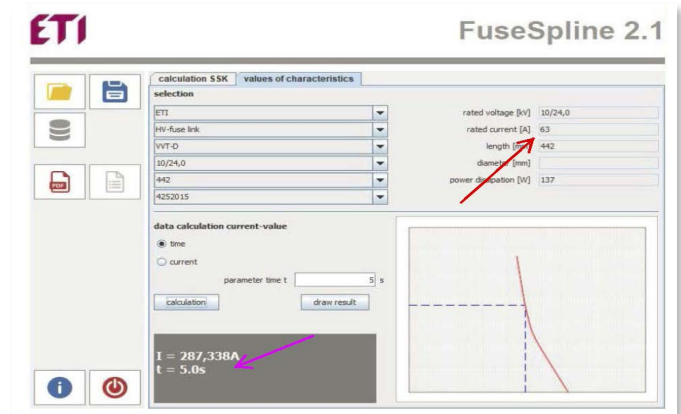

In addition to the calculations described so far, FuseSpline can be used to calculate - determine which switching cells or RMUs (ring main units) are suitable for a particular type of ETI VV fuse link, but I think this area will be covered in a future UTRIP article.

Jernej Pisanec

# Control and protection, Dom 24 h – the smart home of the future for a comfortable and healthy living and working environment

Marles hiše Maribor, d. o. o., together with a consortium of 12 associated companies, has developed the idea of the smart home of the future. The home of the future provides a modern living and working space that follows the guidelines of home working and relieves the employer from the cost of renting offices.

Dom 24 h provides a complete electrical, thermal and information supply for living and working spaces. It contributes to the concept of a net zero energy building by being largely energy self-sufficient, thanks to its solar power plant and electric batteries, where surplus electricity is stored, with the use of super-insulating materials, a highly efficient ventilation and heat recovery system, the use of phase-change materials, high-quality paints and moisture-control coatings and a net zero energy building concept.

The integrated electrical protection and control equipment from Eti, d.o.o. and Robotina, d.o.o., which have joined forces in this project, also contribute to the concept of a net-zero energy building.

The electrical switchgear incorporates differential current protection switches, circuit breakers, contactors, mechanical and solid state relays and KZS differential current protection switches with overcurrent protection, which measure the electrical energy through the voltage drop across a temperature-independent resistor. The ACS switch collects data from the resistor, provides differential and overcurrent protection and transmits the data to a concentrator, which sends the data to an internet network via a gateway.

On higher power consumers, current transformers with the possibility of analysing various parameters (mains voltage, currents, frequency, operating and reactive power) and AC protection switches with arc detection are installed, which, by analysing the voltage and current signal, detect the form of the signal indicating the presence of an arc in the installation and thus switch it off. In this way, they help to prevent the occurrence of a fire at the installation.



Finished distribution board

The control part is used to control the heating (a two-way heat sub-station is installed to return heat to the district heating system), the blinds, the underfloor heating valves, the ceiling cooling valves, the heating water supply to the storage tank, the drinking water valves and the rainwater valves, openers, room thermostat, scene controller, LED strip brightness adjustment, door limit switches, occupancy sensors, outdoor light sensor, water spill detectors, heat pump, solar power, battery system and touch screens for operation.

Communication between the devices is done using different protocols over LAN and WAN (modbus TCP/IP, restAPI, MQTT, socket sending), serial connection (RS-232 and RS-485 or modbus RTU), Canbus and wireless Z-wave connection. From the various devices communicating with each other using one of the above protocols, information flows through the concentrators to the gateway to the IP network. Through the IP gateway, it goes to one or more distributed servers for the provision of cloud services.

The lighting is controlled by a DALI digital addressable lighting interface. The DALI protocol allows individual or group control of luminaires and reliable communication via bus line.

Dom 24 h is a demonstration of a residential and work facility with state-of-the-art materials and state-of-the-art technology that increases individual comfort through simple operation, facilitates various tasks, saves time and costs and increases the safety of people and their property.



Illustration of the Dom 24 h concept

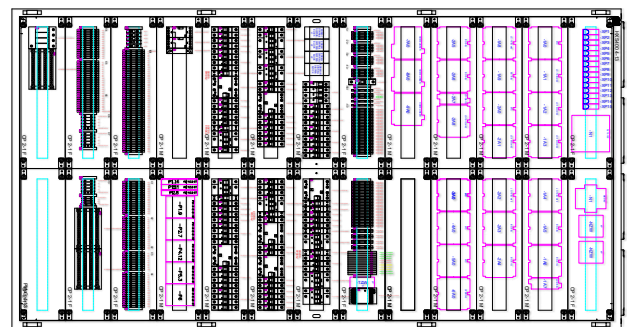

Scheme of the distribution board



Jure Ferk

# Industry 4.0 at ETI

Industry 4.0 was a new term a few years ago, but nowadays it is seen as normal, which is also the case at ETI. There are many answers to the question of what Industry 4.0 actually means as well as how individual companies experience and integrate it into their processes.

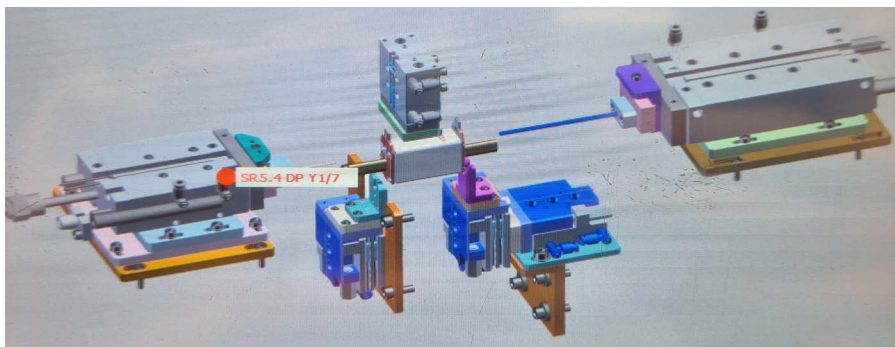

using the Rewo application and the list goes on and on. What is essential to the story of Industry 4.0 at ETI is the fact that, in principle, all solutions have been developed and implemented on the basis of identifying needs and, secondly, that new solutions are being developed and implemented all the time. A very good practice is the creation of a lean office department, which, among other things, acts as a link between all other departments in order to achieve higher productivity, which is, after all, one of the key objectives of Industry 4.0.

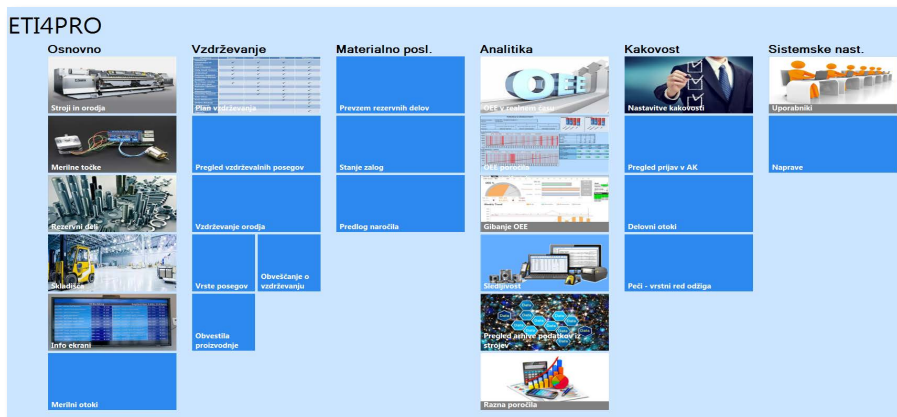

But the whole story should not forget the other departments, each contributing in its own area to the achievement of the objectives and vision. Industry 4.0 has therefore existed at ETI for some time and is constantly being added to and developed. And what will it be like in ETI in a few years' time? We don't know; we might even call it Industry 5.0, as some articles are already saying. But we can say with certainty that it will definitely be different, because the vision is definitely focused on increasing paperless processes, introducing artificial intelligence and ultimately strengthening the link between production and other business processes within the ERP or Infor system.

ETI started talking more concretely about Industry 4.0 as we know it today in 2016, when we participated in an expert economic delegation meeting in Germany, where energy efficiency and Industry 4.0 were the main topics of the event. Based on the information and good practices we gathered, we set out our objectives, which were updated and modified as necessary over time. One of the key objectives was to capture data from the machines, devices and production processes themselves and to further process it into meaningful and useful content. However, the capture of the data itself is key to all the steps forward, with the primary concern being to ensure the reliability of the data captured as well as the knowledge of the data content itself. This is how data capture is done today throughout production, from the simplest to the most extensive and complex data.

Today, we can say that we have succeeded very well in this key objective, among others, as the automatically generated OEE report is one of the key tools for decision-making and problem-solving in manufacturing.

At ETI, we also perceive Industry 4.0 as much broader than just data capture and processing, because during this time we have developed, among other things, the ETI4pro platform, a software interface for monitoring the technical availability of machines and devices, an interface for the graphical display of machine stoppages and faults and an application for the control and management of lines or individual devices with the ability to connect to the Infor system as well as for archiving of data for the purposes of traceability of products, the introduction of video instructions

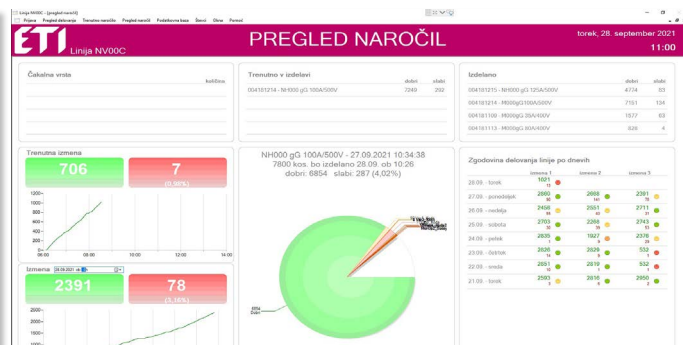
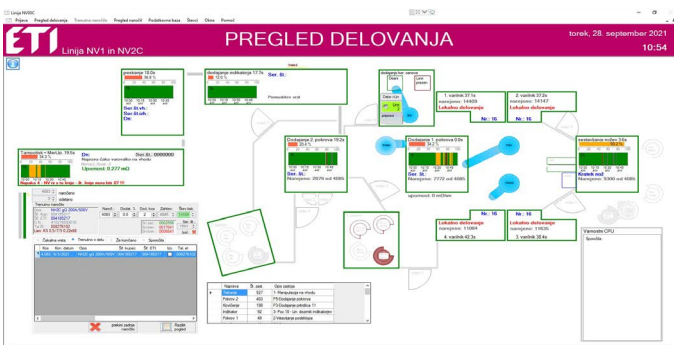
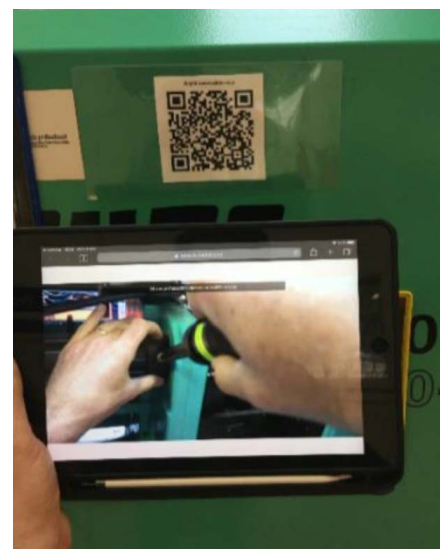

Simon Kovač

# New automatic production line for NV1 and NV2C fuse links

The new NV line will be able to produce size 1 and 2C fuse links, which were previously produced on Line 5. This will reduce the cost price of the product and increase production capacity. An additional objective was to standardise production at ETI Polam and switch to KOMBI fuse link production only. All this will allow us to further grow our market share and profitability of the NV range.



Automation has been a major theme in more or less all production areas within the ETI Group in recent years. Focusing on the NV fuse link area, automation started in 1995 when the RAPS line was the first to be produced. Then, as part of the transfer of NV fuse link production from JM, two assembly lines were moved to ETI from 2000, known as Line 4 and Line 5. These three lines were used for many years to produce fuse links in sizes NV00C, NV1, NV2C, NV2 and NV3C with aluminium (Al) or plastic (ISO) caps.

Automation then came to a halt for a while until market conditions and the need to increase production capacity, market share and profitability growth again encouraged us to accelerate the trend of automating the production of NV fuse links. A strong focus on NV fuse links was also part of the Group's strategy for 2016/2020. This led to the production of the new NV1C automated line in 2016, which was the first time that ETI Proplast produced a fully automated line. The new line was used to switch from manual to automatic assembly of fuse links in sizes NV00, NV0 and NV1C Al versions. The next automatic line, designed to reduce the cost price of the product, to achieve higher production volumes and to replace Line 4, was the NV00C line, which was produced at the beginning of

2020. This new line produces NV00C Al and ISO fuse links.

During the production of the NV00C line, discussions have already taken place as to which new automatic line we will focus on when ETI Proplast capacity becomes available. Based on sales and market information, we decided that the most sensible step at that point in time was to develop a new line to replace all or part of Line 5. During the decision-making process, several possible solutions for the development of a new line were presented. In the end, the decision to build a line to produce NV1 and NV2C Al and ISO fuse links prevailed.

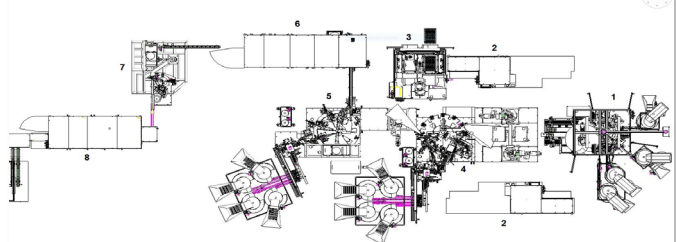

Presentation of the line by assembly unit

At the beginning of the development of the new line, we also had a thorough discussion about whether we should stay with the existing KOMBI construction of the NV1 and NV2C fuse links or whether it would be more cost-effective to switch to the (still KOMBI) design with the principle of riveting the knife and the fastener and thus welding, as is done in ETI Polam (we also have a similar fuse link construction in our production). After analysing the material costs of both versions and the additional costs of obtaining new certificates, we finally decided to stick with the existing KOMBI design.

The NV1/2C line thus starts with Unit 1, which is the riveting unit for the contact knife blade sub-assembly with a base. The unit has four dosing units for dosing contact knife blades and bases. As two different types of fuse links are produced, size 1 and size 2C, the unit has to adapt to this and use the correct sized type of contact knife blade for each type. However, the bases are identical for both types.

The sub-assembly is then inserted from the riveting unit by robot manipulation into the 4 units for cutting and welding the fuse elements (Unit 2). The line has 4 identical units where the fuse elements are produced or »punched« from the pre-perforated and soldered strip according to the nominal flux of the fuse link. The unit then welds them to the metal subassembly of the contact knife blade with a base. The number of welding units was determined to achieve the desired line cycle. Each unit has »recipes« for the rated currents of all characteristics and fusing element voltages. The recipes define the width of the fusion elements, the welding

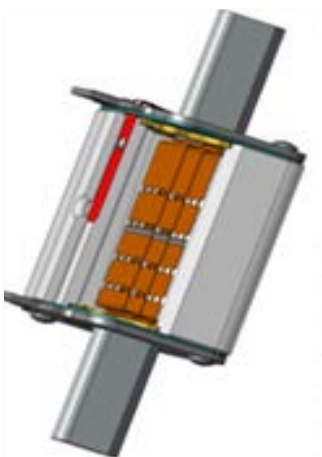

Comparison of constructions





position per sub-assembly and the welding parameters themselves. From the welding unit, the sub-assembly is then inserted, again by manipulation of the robot, into the base of the fuse link located in the circular table 1 (Unit 4). The addition of the base to the circular table 1 is carried out via Unit 3, which has been newly developed specifically for the needs of this line. In the design of the new automatic base removal system itself, we had in mind, first and foremost, to make the operation as simple and ergonomic as possible for the operators and optimal for the line itself. The warp transport trays are designed in such a way that the bases can only be oriented in a certain direction, which is then suitable for automatic manipulation in the line. From this unit, the base is also transferred by manipulation with a robotic arm to the bed of the circular table, where, as already stated, the welded subassembly from the welding units is inserted into it. The operation of inserting the welded sub-assembly into the base has received considerable attention during the manufacture of the device, as it is one of the most critical parts for the optimum operation of the fuse link. The optimum positioning, even at lower nominal currents, is further ensured by the sub-assembly gripping handles in the subsequent steps in the circular table. These grippers are also used to achieve the optimum position of the contact knife blade for the unit in the circular table 1, where the first cap is then applied. The caps are fed into the line via dosing units, where, regardless of type, the insert is also added. The types of caps are differentiated according to the material (Al or ISO) and the size of the fuse link (1 and 2C). The next units in the circular table 1 are then the screwing of the cover and the first measurement of the cold resistance, which, in the event of a fault, eliminates the bad piece at this stage. The presence of the screw and the achieved screw travel are also checked during the screwing process.

The fuse link is then transferred from circular table 1 to circular table 2 (Unit 5) by robotic manipulation. In circular table 2, the operations of circular table 1 are largely repeated. The second cap is added and screwed on. From this unit, the assembled fuse link goes into the indicator assembly unit (Unit 6). In this unit, the indicator spring is inserted and the indicator wire is routed. During manufacture, there are several inspection units to check that the indicator is correctly inserted. In the event of a loose or missing indicator, the line itself ejects the fusing element.

The almost fully assembled fuse link is then transferred from the indicator assembly unit via a conveyor belt to the sand blasting unit (Unit 7). This part is basically quite similar to the other blasting units on the RAPS, NV1C and NVOOC lines. To achieve the desired line cycle, one more blasting point has been added than on the other lines (6 instead of 5). The unit also has a needle indentation measurement to ensure the correct level of fuse link sanding. However, as they say, »the devil is in the detail«. As this is an NV1/2C size, the volume of the base to be filled with sand is 40% higher

than for say an NV1C size. However, to achieve the desired line cycle, the blasting time was not allowed to increase by the same percentage as the increase in volume. In order to achieve the optimum times and also the optimum sand compaction in the fuse link, a new sand dosing method had to be developed that utilises the full volume of the hole in the cap for the sand flow. This has resulted in a much faster sand flow into the very base of the fuse link, and we can now fill the fuse link with a sufficient amount of sand in just 40 seconds.

From the blasting unit, the fuse link then goes to the back of the line (Unit 8). In this unit, the fuse link is first subjected to a final cold resistance measurement. As part of this measurement, it shall be checked once more whether the installation of the vibration indicator on the blasting pad is still suitable. A date code and plate are printed, which are selected according to the type of fusing element. The route of the fuse link through the entire line concludes at the packing table. The ergonomics of the workplace were also kept in mind in the design of this part. This has been achieved by ensuring greater autonomy of operation of the line, which can run for up to 10 minutes without packaging.

The entire line will be monitored by a control system which, as on the NVOOC line, will allow traceability via a QR code. The QR code will record data for welding parameters, cold resistance, indicator suitability, sanding level, etc. A great deal of emphasis has also been placed on occupational safety on this line in the case of use and operation of the line. As can be seen from the unit-by-unit description of the operation of the line, there will be 6 robots operating on the line, which could pose a major hazard if safe operation is not given due attention. The areas where the robotic arms will operate are enclosed by a barrier. ETI Proplast has paid great attention to the access regime to ensure that it is optimally safe for the operators.



As we decided at the beginning of the line to stay with the existing KOMBI version, we did not have much development work with the fuse links themselves this time, as it was more a case of transferring the technology from Line 5 to the new line. However, there were many challenges that we had to deal with during the production of the new line. Finishing or reworking of certain components was necessary. We had some challenges and troubles with the sub-assembly of the base and the related correct functioning of the dosing units. The ISO cap also had some modifications to achieve optimum flatness for automatic loading.

However, the most work in terms of the fuse link was the validation itself. More than 600 pieces of fuse links were subjected to measurements, which were defined with the help of the quality department in a PVP-R document. The production validation plan and the planned measurement reports are recorded in the document. The test plan included 29 different types of tests covering most of the electrical and mechanical tests prescribed by the IEC 60269 standard. However, based on past experience and specific market requirements, we also performed a few above-standard tests.

From the written input requirements issued on 26 February 2019 to the near completion of the line in October 2021, time has passed quickly. In between, there were many coordination meetings to agree on the details of the production of the line. Many hours have been invested in the development, design and manufacture of the new line by ETI Proplast. Still during the development and production process, some things »escape us« or could have been done differently/better. We need to take note of this and implement potential findings in potential future lines. However, each new line further proves and reinforces our thinking that such issues can only be resolved through open communication, collaborative problem solving and a positive attitude. Finally, I would like to thank everyone who has been involved in any way, and will continue to be involved, in the creation and running of the line for the work they have done, which has been no small amount.

Andraž Pušnik

# Update of the FI relay process

The equipment used so far in the FI relay process was purchased from Schiele in 1994. The year already indicates that the equipment has been with us for a long time and is therefore very worn out. With outdated technology, it is difficult to meet production quality standards, which are constantly being upgraded.

The FI relay is a sophisticated component of differential current switches. A tuned magnetic circuit in the relay and a suitable spring determines the desired fault current to which the FI relay reacts. Trigger action of the FI relay is executed in the event that the spring force overcomes the force with which the magnetic force holds the armature closed on both yokes. The needle in the relay, when the FI relay is triggered, causes a shock to the switch mechanism, which causes the differential current switch in this case to trip and stop conducting current to the consumer.

As part of the revamp of the switch production, the opportunity arose to revamp the FI relay process. Initially the process layout was planned for a new hall, next to the new EFI switch assembly line, but subsequently a site became available where the old EFI switch was being hand assembled.

## Preliminary state of the process

The existing process started with the assembly of the magnetic system on the OKU machine. Here the L and S yokes are welded, copper foil is added and a permanent magnet is welded into the core of the sub-assembly. The magnet systems have a magnetic air gap and the next machine dispenses the adhesive into it, which cures inside. This prevents the magnetic system from collapsing when too much force is applied. The magnetic systems are then fixed and sanded using a low melting point metal. This is followed by brushing to remove any debris from the edges that may damage the contact between the two yokes and the armature during the actual operation of the relay.

The shaft and anchor are also assembled manually. We use a special T-shaped shaft where the top of the shaft is pushed through a hole in the armature. The assembly is then clamped in place using a leaf spring.

The manufactured sub-assemblies and the rest of the components are washed completely in a washing line and arrive in the clean room where the relay is assembled. The assembly of the relay is done by hand, with several workers assembling the relay into the final product.

This is followed by thermal ageing of the relay in the furnace. As a final operation, the relay is placed in a test centre where it is first aged mechanically, then its input impedance is measured and finally it is magnetised to the desired breaking current. Throughout the test process, the FI relay is tested and, if necessary, eliminated in the event of inadequate measurements.

## New process status

The aim of the process reengineering is to replace as much of the worn-out equipment as possible, to make the product less expensive by

automating assembly and to raise the quality of the product itself. This includes replacing some equipment, which will have an impact on product quality, and automating some operations, which will improve quality and productivity. The construction of a new clean room, taking into account the latest guidelines for maintaining a clean room regime, will be carried out in conjunction with the relocation.

## New devices

The two lapping machines and the new lapping clamps were developed in cooperation with the Swiss company Michlig AG, with the aim of creating a new way of clamping for lapping applications. The existing solution for clamping magnetic systems with low melting point metal is quite ecologically inadequate and the clamping device itself is also quite worn out.



Brushing device

To this end, we have developed a mechanical clamping device into which the magnetic systems are loaded and clamped with a cap. This clamping method makes it easier to predict the final heights of the magnetic systems and also makes it easier to wash the magnetic systems after machining. In line with the new clamping systems, we have also ordered two new lapping machines to enable a more controlled lapping process.



The post-renovation process



Magnetic system repositioning device



The brushing device was ordered from AFT Habjan, Trbovlje. The machine is designed to smooth the edges after grinding magnetic systems. It allows us to have greater control over the brushed surface but also greater control over the working parameters. The device uses more brushes than its predecessor, which reduces the number of brush changes.

The magnetic systems transfer device is manufactured by ETI Proplast, d.o.o. The device transfers magnetic systems from the lapping clamps, which hold 69 pieces, into the magnetic system washing cages. The device consists of four sub-units, each containing one clamp bed and four cage beds. It is very important for magnetic systems not to dry out

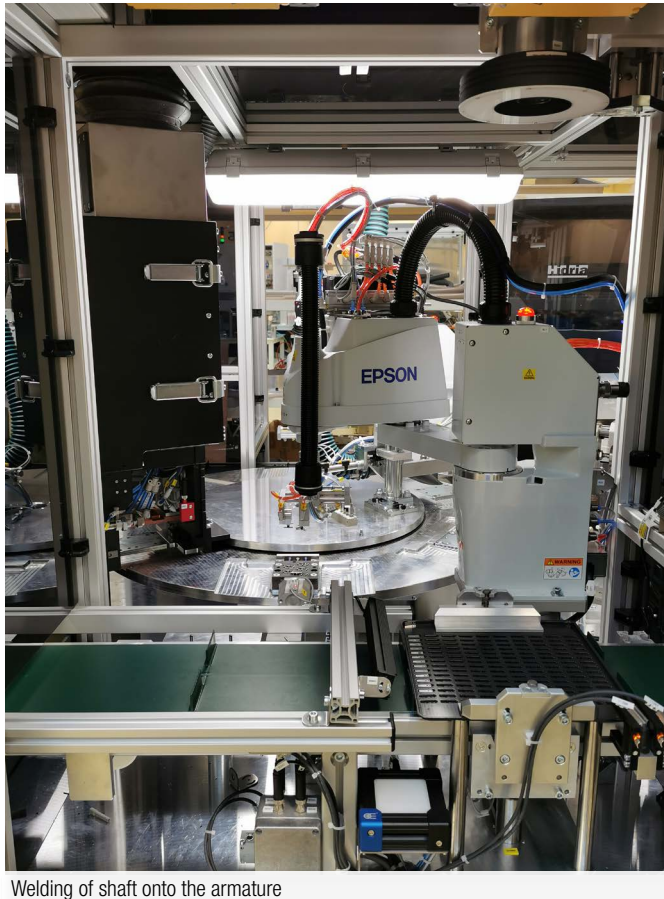

Welding of shaft onto the armature

during the machining process, so with this machine we have ensured that the workpieces are always immersed in water when they are not being repositioned.

The manual assembly of the leaf spring and shaft to the armature is replaced by a shaft to armature welding machine. The machine automatically removes the sheaves from the supplied trays, further aligns them and deposits them in the welding beds. At the same time, new shafts are removed from the vibrating container, which are then sent to the separation unit by air via a hose. The adjusted shaft-armature sub-assembly is laser welded in the bearings on the rotary table at two points where laser welding is used to pierce the shaft through the anchor to the shaft, thus creating a joint. The machine then deposits the welded sub-assemblies in the washing cages. The device was manufactured by Hidria, d.o.o.

The device for automatic installation of FI relays was manufactured at Hidria, d. o. o., Koper. The device comprehensively replaces manual relay installation. All components have to be supplied to the device and at the same time the assembled relays have to be removed at the end of the line. During the automatic assembly process, seven different vision systems are functional to ensure the correct assembly of the final product. The most important vision magnetic system inspects the surfaces at the top of both yokes, L and S, to ensure that no contamination will occur inside the relay or at the yoke-to-armature joint. The line is also provided with turbulence blowdown on all plastic components and on the entire assembly prior to covering.



Device for automatic installation of FI relays

The new clean room was designed and built by Iskra Pio. The relocation was an ideal opportunity to redesign the cleanroom, as the existing cleanroom could no longer provide adequate conditions. The new cleanroom has an ISO classification of ISO8, which limits the maximum number of dust particles in the room. This is achieved by adequate air circulation in the system through HEPA filtration. The cleanroom also contains two transfer chambers. The transfer chamber as well as the transition room are interlocked, which means that only one door can be open at a time to prevent contamination. In the cleanroom, an overpressure based on the outside space shall be maintained, i.e. +25 Pa in the passage room and +50 Pa in the cleanroom. This ensures that the air flow is always directed outwards in the event of opening. The air in the cleanroom is drawn into the space from the ceiling and moves towards the floor where it is exhausted by means of exhaust ducts at the floor.

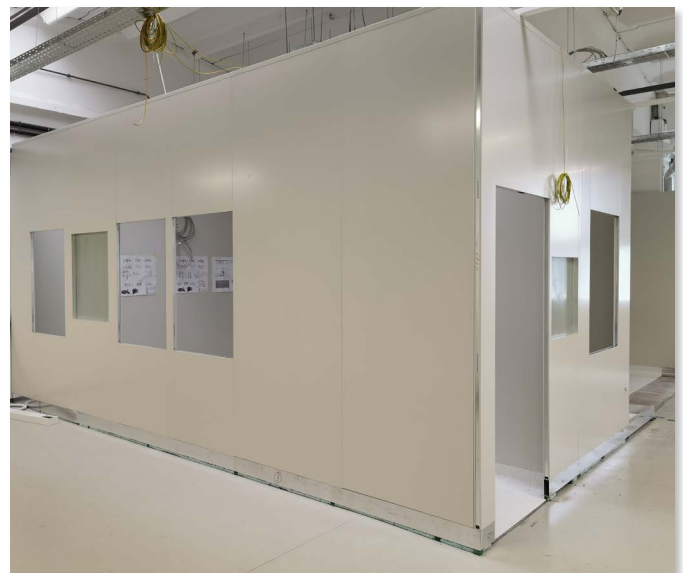

Clean space during the construction phase

### The project

The project unofficially started at the end of 2019, when we started to solicit offers for the devices. During 2020, offers were renewed, suppliers were selected and testing was carried out. Most of the devices have already been partially manufactured this year. This year, we have spent a significant amount of work on optimising the devices themselves with suppliers and moving premises. The total value of the project, or all the investments, is €1.6 million.

# Interview with Kristijan Vlašić,

## the new director of ETI Croatia

### 1. Can you briefly describe your educational and professional path and the most important achievements so far?

After completing the Professional Undergraduate Study of Electrical Engineering, I got a job as a Power System Designer. While working, I continued my education and completed a Graduate Specialist Study of Electrical Engineering and became a certified Electrical Engineer at the Croatian Chamber of Electrical Engineers.

Before coming to ETI, I spent 11 years designing various medium and low voltage energy systems.

I am very proud to have participated in power supply and energy equipment projects for more than 100 km of highways in Croatia and Bosnia and Herzegovina.

I had the opportunity to work during the development of LED lighting on the first major project of the reconstruction of the existing lighting of a large Zagreb junction, and I must admit that this junction has been functioning flawlessly for about 10 years now, while the lighting level is just excellent.

Although I have participated in many projects, perhaps my greatest joy comes with working on the project of freestanding distribution KVR cabinets at ETI.

We created the entire project from scratch at ETI Zagreb, and we were able to ensure the realisation of the first project and delivery to HEP in 2019, but I am even more proud that we participate in these projects every year, and since 2019 we have successfully delivered more than 800 equipped KVR closets.

### 2. What can you tell your readers about your private life? (hobbies, points of view on life, family ...)

Firstly, I am a family man who likes to socialise and spend my free time with family and in the company of dear people. Nowadays, the pace of life has become quite fast, and I like to spend every free moment with my family.

Since there is little free time, I prefer to use it to travel and discover new destinations both in Croatia and the rest of the world.

I use every opportunity to go on an excursion or trip with my family.

Unfortunately, COVID-19 slowed down some of our plans, but I used this time to travel more through Croatia with my family. My wife has always loved to travel and we got along very easily in that part, but I have to admit that my daughter also got to love it, and we enjoy getting to know new countries and cultures all together.



### 3. How do you cope with the new leadership role at ETI Zagreb? Was the transition difficult?

Considering that ETI Zagreb has been operating for 12 years and that current Director Zlatko Reinholz has done an excellent job and laid excellent business foundations, and that during the last 5 years of my work at ETI Zagreb we worked together as a team, the transition to ETI Zagreb was not actually difficult.

Surely the biggest challenge will be to justify the trust I've gained from the Management and maintain the excellent results of current Director Zlatko, but it is a challenge that I am ready to tackle.

### 4. What are your main tasks and goals for ETI Zagreb in this strategic period?

ETI Zagreb functions as a representative office of ETI in Croatia and our main tasks are of a technical and commercial nature. As ETI agents, we promote ETI not only with our distributors but also with other end-customers in the market.

Our five-year business strategy until 2020 had clear and concrete objectives that we were able to achieve, while the new strategy is planned as a continuation of the previous one with the implementation and development of new ideas, as it is clear that our strategy was well affected and there is no need for drastic changes.

For the last 5 years, we have been working intensively on the promotion of the ETI brand among designers and installers, and we intend to maintain and strengthen this model in order to continue and increase the results achieved so far.

### 5. In your opinion, what are the main advantages of the ETI Group and in which areas are there many other

### opportunities that we have not yet seized?

ETI has been represented in Croatia for many years in the building sector and distribution of electricity with components, and we also have a large number of customers satisfied with the quality of our products, and this is a part that we must maintain in the future, because it is the basis of our sales as well as our main advantage.

Since I came to ETI, I have been in charge of expanding the program, and I definitely see opportunities to expand into projects within the industry and energy in parts where ETI has not been represented so far, so the future is certainly in expanding SI products to ensure increased sales of our own production.

### 6. What is your vision for ETI in the future?

ETI certainly needs to maintain and strengthen its position as one of the leading manufacturers of fusible plugs and switches and become a recognisable brand alongside large corporations in offering protective and switching equipment for LV installations in all segments of electrical engineering.

### 7. Is there anything else you would like to tell our readers and colleagues?

I would like to thank primarily the Management of ETI, who gave me the opportunity to prove myself in this new position.

I would also like to thank all my colleagues from the ETI Group for their support so far, and I hope that together we will become even better and stronger and strengthen our position in the market as one of the leading manufacturers of protective and switching equipment.



# Daniel Hochrein,

## the new General Manager of ETI ET Deutschland

I'm Daniel Hochrein; I'm 48, married and have a 13-year-old daughter. I live with my family in Würzburg, a beautiful, 1,300-year-old wine town on the Main. In my spare time, I go jogging and take long walks to stay in shape. I played basketball when I was younger; now I volunteer in the local basketball club where my daughter also plays. I like to travel and love good food and a good cup of coffee.

My childhood fascination with electronics and automation had a decisive influence on my career choice. My professional career began in a typical German engineering company, where I designed and programmed various equipment. Before switching to Sales, I was in charge of electrical engineering at a wood processing machinery manufacturer. Before joining ETI, I built a sales team for an Asian company in Germany and went through all the ranks in the drive and control technology sales department. I used the time during the corona lockdown to obtain a postgraduate MBA degree.

In July, I was put in charge of ETI Elektrotechnik GmbH, which is extremely exciting but also comes with great responsibility. Continuing the positive momentum we've seen in recent years is undoubtedly one of my most important executive tasks. Strategically, the challenge will be to further develop the organisation and the processes and, most of all, to make ETI more recognisable as a brand in Germany. My vision for the future, from a medium to long term perspective, is to make ETI known to



every single electrician in Germany. Due to the different corporate cultures, joining ETI was certainly a transition, although a pleasant one. Feeling welcome and the warm reception I received were particularly gratifying. What really impressed me was

the willingness of my German and Slovenian colleagues to help! In times when products become more and more similar and when the competition is fierce, motivated employees make the crucial difference. I look forward to working with you!

Sabina Pešec

## »Looking for Bright Minds« campaign brings record number of applications for scholarships

This year, we have revamped the ETI communication strategy with students of various technology branches – our potential scholarship holders. The main innovations were in the design of communication tools and in the distribution of content. Using imaginative visuals and short videos and with a greater focus on digital communication channels and collaboration with educational institutions, we achieved a record number of new applications for ETI scholarships.

Acquiring quality personnel is one of the most important tasks of each company. One of the more successful ways to achieve this is to reach out to potential employees while they are still in school. ETI has a long history of recruiting technical cadre through scholarships, but this year, we decided to implement some changes in the process. As the need for technical profiles is growing exponentially, the HR department approached Marketing to help attract as many students as possible to apply for the ETI scholarship. The project was very interesting, and I was delighted to join the project team. Of course, we are all aware that building an employer brand that has a direct impact on the above outcome does not happen overnight, so we agreed that the ETI Scholarship campaign would be just a prelude to long-term and consistent communication with this stakeholder group.

The first thing we did in the context of developing our new communication strategy was to organise a team-building exercise with our existing scholarship holders. On the one hand, we wanted to reward and motivate our students even more in their work (practical and academic), but on the other hand, we also wanted to find out what they like about ETI and where we can be better.

Based on the lessons learned from the team mentoring and our knowledge of the situation in the »scholarship market«, we have developed the basic starting points for the campaign. We found that it means a lot to our students that their mentors and colleagues take the time to be kind and supportive to them. So, kudos to our mentors and everyone else in the company who works with our students, you are doing a great job! The scholarship holders said that they also like to be given concrete tasks and to learn as much as they can so that they can then do some of the work themselves. Of course, they also benefit from help with their thesis.

Importantly, unlike some other scholarship providers, ETI also offers scholarships during

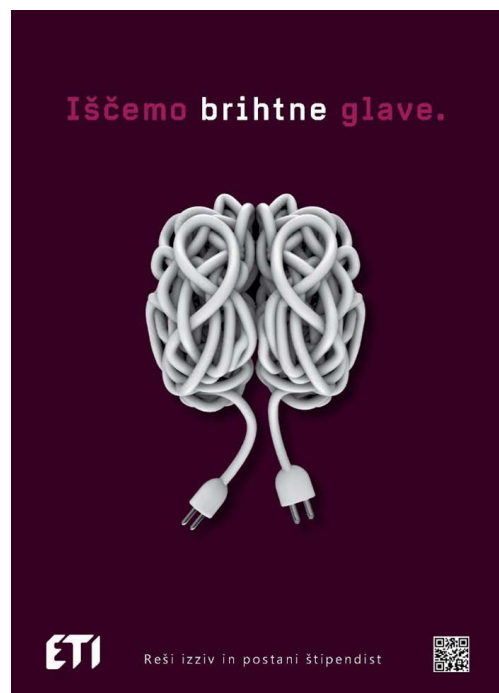

the summer months, rewards scholars for their compulsory internships and holiday work and helps them by part-financing the cost of living in the place of study and subsidising their transport costs.

Last but not least, ETI is a technologically advanced international company, has been declared the Slovenian Factory of 2021 and is the 20th largest Slovenian exporter, which gives our scholarship holders the opportunity to work with advanced technologies and systems as well as the possibility of career development and a secure job in the future.

We then went on to build a compelling visual identity and communication style for the campaign on this basis. The campaign slogan was »Looking for bright minds«. Based on a short market research, we decided on a less formal, more youth-oriented communication style and added elements of gamification, which is currently very "in" in digital marketing. As an additional motivator in the form of a challenge (in line with our slogan), we designed a test related to our industry and products, and each scholarship candidate who successfully completed it and sent it to ETI with their application was awarded a small prize.

In addition to using clever graphics, we also approached our potential scholarship holders in another way, by using the opinions of their peers to illustrate the benefits of the ETI scholarship instead of a boring list. Using the images and video material from the aforementioned teambuilding exercise, we have produced a series of videos where our current scholarship holders tell us why they like it at ETI. And we haven't forgotten to showcase our production and



technology, which I'm sure appealed to many.

We have campaigned both on traditional communication channels, such as posters, leaflet distribution and mailings, advertisements on ETV, radio and various local newspapers, etc., and on digital channels, where we have made a significant leap this year. We decided to use social media marketing tools on Facebook and Instagram, where we launched several targeted campaigns step by step (first image, then video), and we did not forget about SEM or Google search engine marketing. Secondary schools and faculties were also an important channel, through which we distributed flyers and posters, and most of them also published our invitation to apply on their websites and FB communities. Last but not least, as true ETI staff in HR and Marketing, we also built our commitment into the campaign, both in answering phone calls and emails and in communicating with the faculties as well as in checking and guiding the campaign on a daily basis.

We tracked the results throughout the campaign using web analytics (Google Analytics, Facebook Ads Manager and Google Ads). Using Google Analytics, we can see that below the line, compared to the previous year, traffic to ETI's scholarship subpages increased by more than 1400%. During the campaign period, 3,227 users visited these websites, bearing in mind that increasing number of users (especially younger ones) use anti-tracking software, which means that their visits are not detected by Google Analytics. Total number of visits is therefore even higher, which we will see with more detailed analytics.

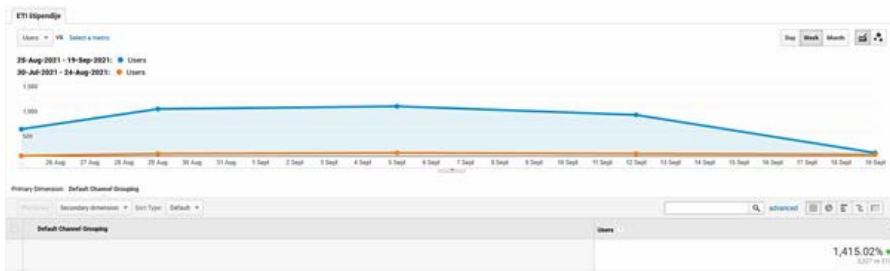

Using Google Analytics, we can see that below the line, compared to the previous year, traffic to ETI's scholarship subpages increased by more than 1400%. During the campaign period, 3,227 users visited these websites, bearing in mind that increasing number of users (especially younger ones) use anti-tracking software, which means that their visits are not detected by Google Analytics. Total number of visits is therefore even higher, which we will see with more detailed analytics.

If we look at where our visitors came from, i.e. which were the most successful communication channels, we can see that during the campaign most visitors came from social media, followed by a direct link (which means that someone typed a direct URL address into the browser box – in our case, this can be mostly considered as access via QR code, which you can see in the bottom right corner of the campaign graphic), followed by organic hits (when someone searches for the selected page in the browser), paid hits (clicks on SEM ads) and finally referrals (posts on other websites – schools, local news pages etc.).

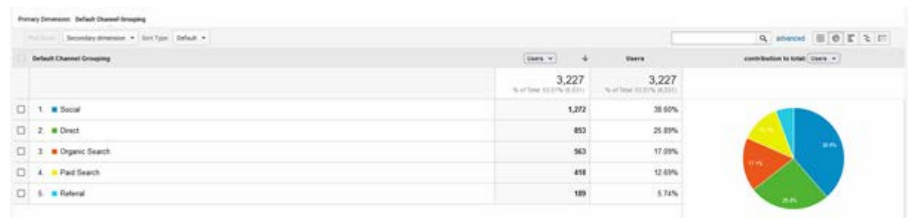

Data from Facebook Ads Manager shows that during the campaign 1,840 users clicked on any (image or video) of our FB/Instagram ads (the difference between GA and FB analytics can be mainly divided into two categories, the first being users who left our website so quickly that GA didn't even detect them, and the second being the anti-tracking software users mentioned before), and the ads were shown on the walls of 39,012 different people. Of these, 6,452 liked, shared, commented on the ads shown, and 4,587 users watched our videos.

Of course, we must not forget the effectiveness of traditional communication channels. On 6th September, we sent a flyer to all households in the selected regions, of course with the QR code, which led to the ETI's online scholarship subpage. The result of this part of our campaign is clearly visible in the GA tool:

Of course, we have to be aware that this is only data on how many users wanted to find out more about our scholarships. What we are missing is the conversion data, in our case that means scholarship applications sent. The reason is that we used an existing application form that had to be filled in and sent by regular post. Next year we will also digitise this part of the process,

which means that interested parties will be able to submit their application online. This will make the process more user-friendly and bring it closer to youngsters, who probably find sending documents by post as anachronistic as we find faxing. At the same time, it will give us insight into conversion, i.e. which of the channels is most effective for our main goal.

At the moment, however, we can only work with some of the data obtained by the HR department. First and foremost, the campaign was a great success. A record number of people applied for the scholarships. When interviewed by the HR department, the candidates said that they had found out about the project via the internet (our website, Facebook, etc.), flyers, school and college websites and from parents or acquaintances who work at ETI. Since 19th September until today, the candidates have also gone through the selection process and the potential has proved to be enormous. This is why the management has also got involved and has significantly increased the number of scholarships offered this year to all selected candidates.





Vlasta Cirar Vovčko

## Responsibility and solidarity - the guiding principle of the ETI Group during COVID-19

For almost two years now, we have been living, working, and creating in significantly changed conditions that we haven't experienced before, and did not even expect. Back in February last year, we doubted that a very contagious disease would come to us, to Europe, and cause a global pandemic. However, COVID-19 soon became a reality in all countries where the ETI Group has its people, its employees. Overnight, we had to adjust to a new way of coexisting and working. We were tormented by a lack of information, a lack of protective equipment, and we were gripped by considerable fear. Here, for the first time during the corona crisis, solidarity between the companies in the ETI Group was expressed. Without hesitation, we helped each other to obtain protective equipment, especially protective masks, and distributed them from where there were enough of them to where they could not be obtained due to market conditions. We also exchanged experiences, and knowledge about measures to prevent the spread of this infectious disease. We had a clear goal in front of our eyes. To maintain the health of everyone in the ETI Group and the health of our family members, as well as the well-being of the ETI Group as such, by minimising stoppages of production and other business functions due to COVID-19. We all acted responsibly, adhered to the prescribed measures, and reduced the intrusion of infections into our companies, and the spread of infections within the companies.

We quickly realised that just our internal actions would not be enough to overcome the COVID-19 crisis. As a company and as individuals, we are heavily dependent on the local environment in which we live and work. As companies in the ETI

Group, as well as our employees in their private lives, we participated in several charity campaigns. Perhaps the largest of these are worth highlighting. ETI Elektroelement, d.o.o., together with some other local companies, contributed funds for the purchase of two respirators for Trbovlje General Hospital, which is the closest hospital for most employees. The ETI Group contributed a higher proportion of the value of the two respirators. ETI Polam also made a tremendous contribution to the better care of patients in the local area. Two specialised beds for intensive care patients were donated to the hospital in Pultusk. In ETI, d.o.o. we provided our employees with paid leave from work, to provide voluntary assistance. Four of our employees worked as volunteers at the Izlake Home for the Elderly and the Trbovlje General Hospital. There was a lot of other, at first glance small, but in reality, considerable help from all the companies in the ETI Group, and all the employees to the local area. All the time, and even more intensively during the health crisis, we help local communities in various other ways.

After the initial difficulties and fear, we quickly got used to working under the new conditions. Today, we can proudly say that, thanks to the responsible conduct of each and every one of us, we didn't have to stop production and business. Of course, we worked less at certain times because many employees were absent due to the coronavirus, but there were no complete shutdowns. This year, we have proved that in the meantime, we have not forgotten our responsibility to ourselves, to our loved ones, and to the ETI Group. In almost all the companies in the ETI Group, we have achieved higher vaccination coverage than the local

average. In Izlake, because of the availability of the vaccine, and also because the local legislation and the local health system allowed us to do so, we organised vaccination against COVID-19 on several occasions at the company's headquarters, and encountered a very good and positive response from the employees. At the time of submitting this article, we are preparing to organise a booster dose vaccination at the company's headquarters. We are also continuing to show solidarity between the companies in the Group, helping each other with the supply of self-test kits, and also with other means of protection if the need arises.

It has not been easy. The whole situation has affected us all. Both personally and professionally. We did some things well, and others not so well. We kept learning, and striving for a healthy environment. Unfortunately, we also had to say goodbye to two colleagues; one from Bosnia and one from Slovenia. Their deaths are still a strong reminder of the seriousness of the situation we have been in for almost two years. Even today, it is not easy, as we are again facing an increase in the number of infected and quarantined. No matter what, we must not forget the responsibility we have to ourselves, to our families, and to the company. Let's be responsible, and respect the measures to prevent the spread of this infectious disease. Let's remain in solidarity with each other, regardless of our vaccination or corona status. And hopefully, COVID-19 will soon fade into oblivion, and we will be able to move on to the previous way of working, so that working in workplaces with barriers and working through video systems will soon be replaced by more personal contact between us. Let's stay healthy!



Borut Markošek

## Getting Healthy with Exercise – Hiking

Due to the Covid-19 situation, several months passed since our last hike. As soon as the conditions became favourable again, we went hiking.



Mount Mirna mountain lodge

On the first Saturday in June, we climbed the highest peak in the Bela krajina (White Carniola) region – Mount Mirna (elevation: 1047 m), which is situated in the western part of Bela krajina and the southwest edge of Kočevski gozd. It is overgrown with forest. Just below the top is the Mount Mirna mountain lodge (elevation: 1000 m) and a partially renovated church, whose bell tower today serves as an observation tower. From the top you can see Bela krajina, Kolpa River, Kočevski Rog Plateau, Žumberak Mountains, including Trdina Peak, and if the weather is clear, you can also see Zagreb, Žumberak, and Karlovac.

Mount Mirna is nowadays a popular hiking spot. The top can be reached via multiple trails, including a macadam road that leads all the way to the top. The most visited trail is the one with the starting points at the Vrčice Village along the road between Soteska and Črnomelj. Along this educational nature trail, marked with blazes, are many information boards. You can also decide to walk through Škrijl or Planina Village. It will take you approximately 45 minutes to walk from Planina Village to the top of Mount Mirna. If you decide

to hike from the aforementioned starting point, you will need more than two hours to reach the top. The trail is easy and well marked with blazes.

Mount Mirna got its name in 1793. A hamlet formed below the top in the 16th century, and the church of St. Francis Xavier was built there in the first half of the 17th century. According to folk tradition, there is a cave or dragon's grotto at the site of the main altar, and it was said that every year the dragon created clouds and hail that devastated the local fields and vineyards. After seven years of hail, the residents of Bela krajina, Kočevje and Croatia agreed that they would build a church above the dragon's grotto. There was no more hail after that, and the mountain was named Mount Mirna (Friedensberg or Calm Mountain). The church was burnt down during World War II, and then partially renovated in 1993. Its bell tower is today an observation tower.

We went on our July hiking trip on the last Saturday in June due to various reasons. Soča Trail is one of the educational nature trails in the Triglav National Park (TNP) and leads visitors from the source of the Soča River across the Trenta valley up to the park's border near Kršovec, where one of the hiking



Soča Trail





Mount Vrtaško Sleme



Kota 1313



Aljaž Lodge in the Vrata Valley



At the top of Mount Rombon

trails in Bovec ends.

It is the oldest trail in the park. It runs along maintained paths away from roads and passes a plethora of natural, cultural, and historical sights. There are many information boards with educational content placed along the trail, while TNP information posts serve as signposts. The path frequently crosses Soča River via interesting hanging bridges.

The Trail is divided into two circular stages. The first stage of the Trail that leads from the river source to the Log Village in Trenta was established first, while the second stage was established a few years later. It is 20 km long in its entirety; however, it makes sense to hike it in two parts, as due to sightseeing, the hike takes you a lot more time than it usually would.

Information boards, which provide hikers information about the Trail and the Triglav National Park, stand at four locations. These are: Hut at the source of the Soča River, Kugy Monument, TNP Information Centres in Log and Soča Village. There are 16 information spots, marked with boards, along the trail, which describe either general characteristics of the area in the park (flora, animals, geography) or individual sights along the Soča Trail.

This year's traditional two-day hiking trip in August was a bit different due to the coronavirus situation. We went on two one-day hiking trips with two different routes instead of a two-day hiking trip.

The longer route led us from Mojstrana to Mount Vrtaško Sleme (elevation: 2077 m), which is situated between Mojstrana and Mount Kukova Špica. The top is grassy and offers a wonderful vista towards Mount Kukova Špica. From the top, you can also admire a beautiful view of the Karawanks and the entire Upper Carniola. Initially, we ascended steeply through the forest, then continued along a pleasant path past Vrtaška Planina Mountain Pasture and enjoyed the fantastic view of the Vrata Valley and the mountains above it.

The shorter route took us on the Triglavska Bistrica Trail. Triglavska Bistrica is a stream that flows across the glacier Vrata Valley near Mojstrana. Its source is located below the north face of Mount Triglav in the blind Bukovlje

Valley, and it flows past the Aljaž Lodge. In addition to several intermittent torrential tributaries, it has three constant tributaries, all of them flowing from valleys below the east slope of Mount Škrlatica: Dry Creek, Red Creek, and Peričnik Creek (also Peričnik Waterfall). The Bistrica Stream empties into the Sava Dolinka River at Mojstrana. It falls 400 meters during its approximately 10-kilometer course.

Mount Rombon or Mount Veliki Vrh – our September destination – is a 2208 m high mountain north of Bovec.

Mount Rombon is a rocky mountain in the Kanin Mountains, which falls steeply on the north side into the valley of stream Možnica, while an easy trail that starts in Bovec also leads to the top. It is connected to the main Kanin Mountains via the ridge Ribežnov. The trail from Bovec leads past Čuklje (elevation: 1766 m), a peak known for being the scene of World War I battles. The top of Mount Rombon offers a beautiful view of the Soča Valley as well as the Kanin and Mangart mountains, Mount Bavški Grintavec, and Mount Krn. The latter is mostly known for being the mountain with the most artificial tunnels in Slovenia. Truly numerous tunnels were dug during World War I and can still be seen today. The massive Rombon mountain chain was an Austrian rock "fortress" and the scene of constant Italian attacks, as the top of Mount Rombon was an excellent observation point from which you could oversee the entire Soča Valley. Italians first attacked on 15 August 1915 from the direction of Bovec and Plužna via Goričice Mountain Pasture. They took the top of Čuklje on 10 May 1916, where they established an excellent base position for further attacks on Mount Rombon. Attacks on Mount Rombon continued in the second half of 1916, until October 1917 and the 12th Battle of the Isonzo, when Italians were forced to retreat on the entire front all the way to the Piava River under the pressure exerted by the Austrian-German army. Kota 1313 was an Austro-Hungarian artillery observation post during World War I.

(Source: internet)





Šemnik, Urška Gobovc

Sabina Pešec

## Beautiful Zasavje, ETI's homeplace

In the beginning of 2021, when most of Europe was under one or another form of lock down (stricter in some countries, less so in others), which caused that people could not migrate to other regions freely.

So, we at ETI have decided to organize a photo contest of the most stunning places in Zasavje in order to make our readers realize how beautiful Zasavje really is and to help them find new destinations to visit. When the photos arrived, even we were surprised at what charm can be found in Zasavje. Therefore, we decided that such beauty deserves a wider audience, and here we are – this is the representation of what a lovely place ETI's home region really is.

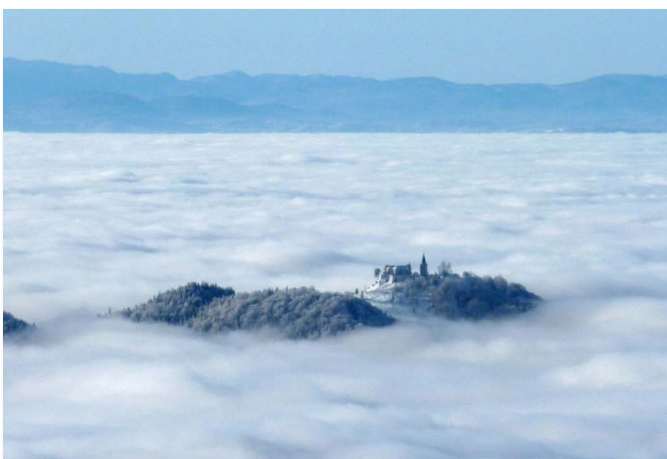

Sveta gora, Dušan Martinčič



Zasavska Sveta gora, Urška Gobovc





Sun in Orehovica, Zdenka Bratec



Čemšenik, Urška Gobovc

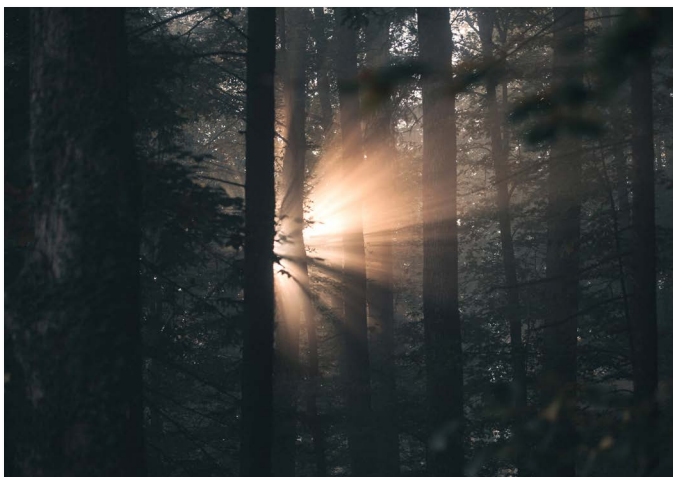

Sunrays, Bojan Bratec

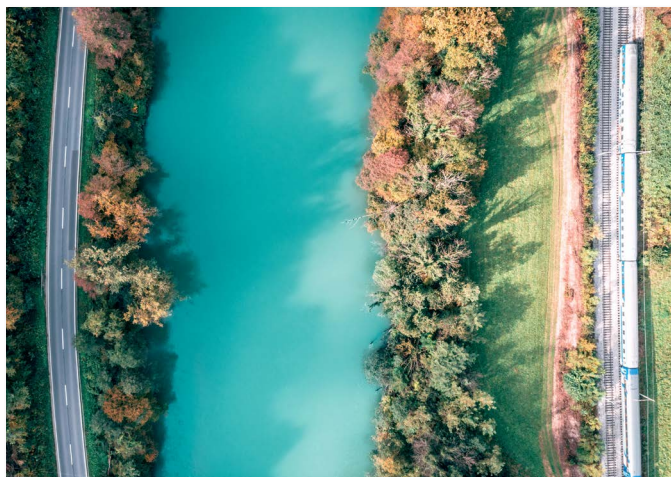

Sava, Lara Bratec

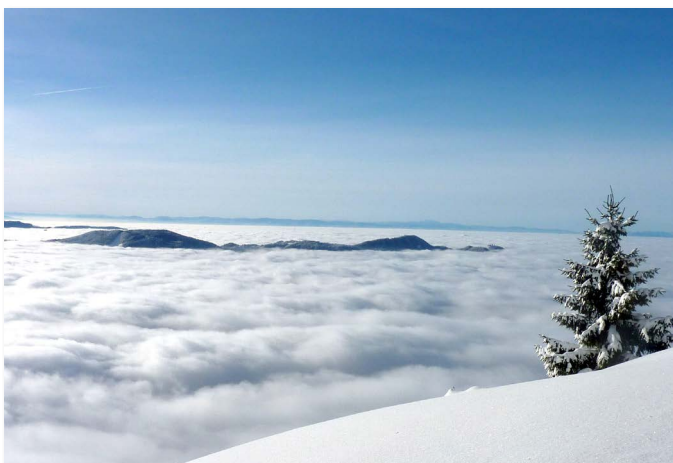

Marela to Sveta gora, Dušan Martinčič



Views from Velika skala nad Kisovcem, Polde Ostrožnik



Views from Ruglovje, Polde Ostrožnik





# Focus on common goals and results



The common goals of ETI Group are our highest priority. We achieve our goals with our energy, ambition, dedication and passion.

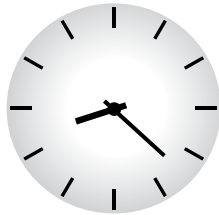
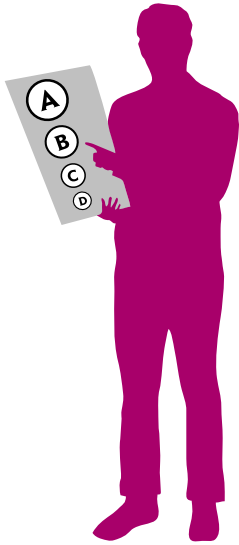

I set priorities and organize my time optimally.



I include my coworkers in the search for solutions.



I persevere on the way to the goal

I bear responsibility for my decisions.

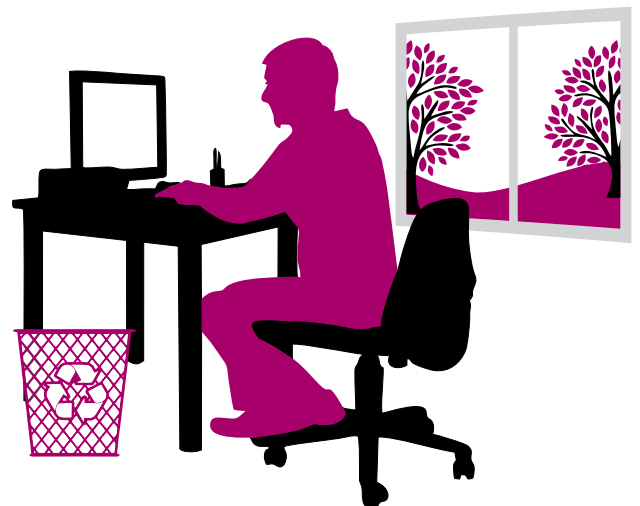

I take care of a tidy workplace and clean environment.

